

NATIONWIDE

03-359 7759

SMITH
CRANE & CONSTRUCTION

GROVE[®]
by **Manitowoc**

GMK6300L

Product Guide



 300 t

 80 m

 12 - 37 m

 120 m

GROVE GMK6300L

Higher and stronger
Höher und stärker
Hauteur et force
Más alto y más fuerte
Piu in alto e piu potente
Выше и сильнее



Features

- Long 80 m seven section boom and optional extension up to 37 m for a max tip height of 120 m.
80 m langer Ausleger mit optionaler Auslegerverlängerung bis zu 37 m für eine maximale Spitzenhöhe von 120 m.
Flèche de 80 m à sept éléments et extension optionnelle jusqu'à 37 m permettant d'obtenir une hauteur maximale de tête de flèche de 120 m.
Pluma de 80 m de longitud de 7 secciones y extensión opcional de 37 m para obtener una altura total en punta de 120 m.
Braccio a sette sezioni lunghezza 80 m e con prolunga aggiuntiva fino a 37 m, altezza massima in punta 120 m.
80-метровая семисекционная стрела с возможностью дополнительного удлинения на 37 м, при которой верхняя часть достигает максимальной высоты 120 м.
- Flexible 21 t heavy roadable counterweight and interchangeable slabs that can be used for GMK5180-1, GMK5200-1 and GMK5250L.
Flexibles Gegengewicht - bis zu 21 t auf der Straße verfahrbar und austauschbare Gegengewichtsplatten mit GMK5180-1, GMK5200-1, GMK5250L.
Contrepoids modulaire de 21 t remorquable sur route et dalles interchangeables utilisables sur les GMK5180-1, GMK5200-1 et GMK5250L.
Contrapeso transportable y flexible de 21 t y placas intercambiables que pueden utilizarse con los modelos GMK5180-1, GMK5200-1 y GMK5250L.
Pesante contrappeso a configurazione flessibile da 21 t per circolazione su strada con lastre intercambiabili che può essere usato per la GMK5180-1, la GMK5200-1 e la GMK5250L.
Гибкая система противовесов массой 21 т с возможностью перевозки по шоссе, а также сменные пластины, совместимые с GMK5180-1, GMK5200-1 и GMK5250L.
- Reliable and powerfull driveline: 450 kW (EUROMOT 3a) or 430 kW (EUROMOT 4) Mercedes engine with Allison full automatic transmission.
Zuverlässiges und leistungsstarkes Antriebssystem: 450 kW (EUROMOT 3a) oder 430 kW (EUROMOT 4) Mercedes Motor mit vollautomatischem Allison-Getriebe.
Système de transmission fiable et puissant : moteur Mercedes de 450 kW (EUROMOT 3a) ou 430 kW (EUROMOT 4) équipé d'une transmission Allison tout automatique.
Sistema de transmisión potente y fiable: motor de Mercedes de 450 kW (EUROMOT 3a) o 430 kW (EUROMOT 4) con transmisión completa automática de Allison.
Trasmissione affidabile e potente: motore Mercedes 450 kW (EUROMOT 3a) o 430 kW (EUROMOT 4) con trasmissione completamente automatica Allison.
Надежная и мощная трансмиссия Двигатель Mercedes 450 кВт (EUROMOT 3a) или 430 кВт (EUROMOT 4) с полностью автоматической коробкой передач Allison.

Jobsite benefits

- Higher and stronger: At a maximum tip height of 120 m the crane is still able to lift 2,2 t.

Höher und stärker: Auch bei einer maximalen Spitzenhöhe von 120 m kann der Kran immer noch 2,2 t heben.

Hauteur et résistance accrues : à la hauteur maximale de tête de flèche de 120 m, la grue reste capable de lever 2,2 t.

Más alta y robusta: con una altura máxima en punta de 120 m, la grúa es capaz de levantar 2,2 t.

Più in alto e più potente: con un'altezza massima in punta di 120 m, la gru riesce a sollevare 2,2 t.

Выше и сильнее При максимальном выдвижении стрелы на 120 м кран может поднимать 2,2 т.



- Be flexible and save logistic costs thanks to interchangeable self-rigging auxiliary hoist and a flexible counterweight.

Seien Sie flexibel und sparen Sie dank des selbstrüstenden Hilfshubwerks und einem flexiblen Gegengewicht bei den Logistikkosten.

Modularité et économies au plan logistique grâce au treuil auxiliaire auto-bloquant interchangeable et au contrepoids polyvalent.

Más flexibilidad y menos costes logísticos gracias al cabrestante auxiliar intercambiable de montaje automático y a un contrapeso flexible.

Flessibilità e minori costi di logistica grazie all'argano ausiliario con auto-allestimento intercambiabile e al contrappeso a configurazione flessibile.

Проявляйте гибкость и снижайте затраты на логистику, используя сменный саморегулируемый вспомогательный подъемник и систему изменяемых противовесов.



Manitowoc Crane Care

The assurance of the world's most advanced crane service and support to get you back to work fast.

Manitowoc Crane Care vereint alle Serviceleistungen von Manitowoc im Produktsupport vor und nach dem Verkauf: Ersatzteile, Service, technische Dokumentation, technischer Support und Schulung, alles unter einem Dach.

L'assurance de temps morts réduits grâce à la meilleure qualité de service et d'assistance pour grues au monde.

La seguridad de contar con el más avanzado servicio técnico y soporte de grúa para ayudarlo a volver rápido al trabajo.

La garanzia dell'assistenza e della manutenzione per gru più avanzate del mondo per riprendere velocemente il lavoro.

Гарантия лучшего в мире обслуживания кранового оборудования и техподдержки, для максимально быстрого восстановления работоспособности.

Manitowoc Finance

Financial tools that help you capitalize on opportunity with solutions that fit your needs.

Individuelle Finanzierungslösungen, mit unseren Kooperationspartnern entwickelt, um Ihre bereits bestehenden Finanzierungsstrukturen zu ergänzen.

Des outils financiers qui vous aident à investir à bon escient grâce à des solutions adaptées à vos besoins.

Herramientas financieras que le ayudan a sacar provecho de las oportunidades, con soluciones que se ajustan a sus necesidades.

Strumenti finanziari che consentono di capitalizzare le opportunità con soluzioni che si adattano alle vostre esigenze.

Финансовые инструменты, позволяющие вам развивать бизнес, опираясь на решения, отвечающие вашим потребностям.

Contents • Inhalt • Contenu • Contenido Contenuto • Содержание

Specification	3
Technische Daten	4
Caractéristiques techniques	5
Características	6
Caratteristiche	7
Технические характеристики	8
Data • Daten • Caractéristiques • Datos • Dati • Данные	9
Dimensions • Abmessungen • Encombrement • Dimensiones • Dimensioni • Размеры	10
Counterweight • Gegengewicht • Contrepoids • Contrapesos • Contrappesi • Противовес	11
Load charts • Traglasten • Capacités de levage • Capacidades • Capacità • Таблицы грузоподъемности	12
Overview • Übersicht • Tableau synoptique • Resumen de las tablas • Tabella riassuntiva • Общие сведения	13
Working Range • Arbeitsbereiche • Diagramme de levage • Gama de trabajo	
Area di lavoro • Грузовысотные характеристики	14
Telescopic Boom • Teleskopausleger • Flèche principale • Pluma telescópica	
Braccio telescopico • Телескопическая стрела	15
Working Range • Arbeitsbereiche • Diagramme de levage • Gama de trabajo	
Area di lavoro • Грузовысотные характеристики	22
Jib configurations • Kombination der Auslegerverlängerung • Combinaisons de l'extension treillis	
Configuración con extensiones de pluma • Combinazioni delle prolunghe del falcone • Конфигурация стрелы	23
Swingaway (hydraulic luffing) • Klappspitze (hydraulisch wippbar) • Extension treillis (déport hydraulique)	
Plumín (angulable hidráulicamente) • Falcone (brandeggio idraulico) • Удлинитель стрелы с гидравлическим изменением вылета.	24
Symbols • Symbolerklärung • Glossaire des symboles • Glosario de simbolos • Glossario dei simboli • Символы	39

Dimensions • Abmessungen • Encombrement Dimensiones • Dimensioni • Размеры

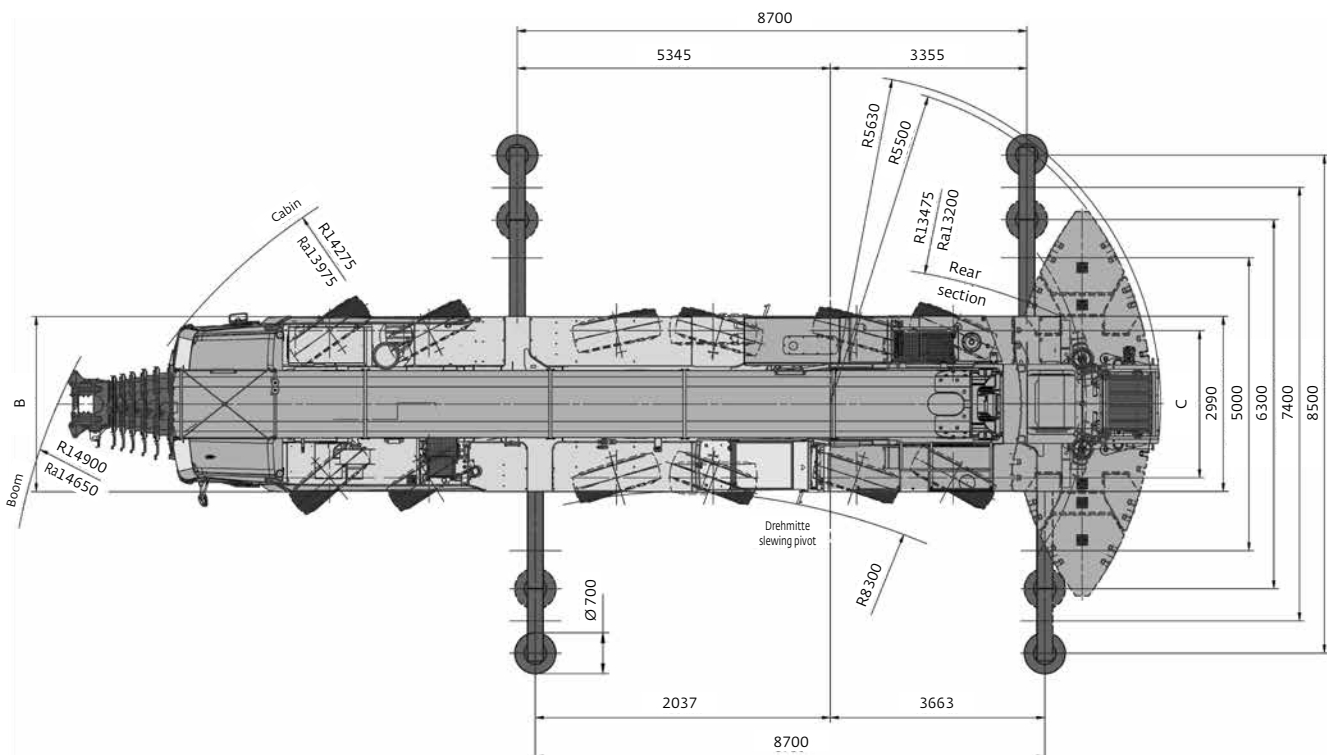
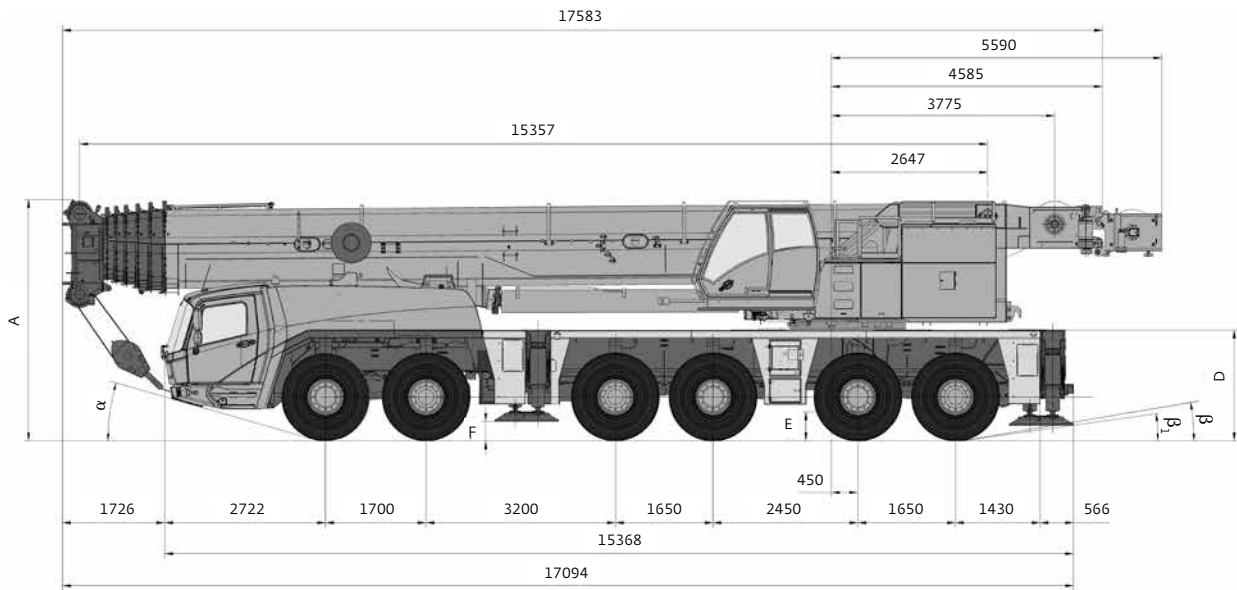

Ra = Radius all wheels steered • Radius allradgelenkt • Rayon toutes les roues directrices • Radio de giro con todas las ruedas giradas • Raggio di curva con tutte le ruote sterzate • Радиус новопомпа нпу управління всіма колесами

	A	A 130 mm**	B	C	D	E	F	α	β	β_1
14.00 R25	3950	3820	2970	2570	1822	400	297	14	8	6
16.00 R25	4000	3870	2975	2510	1872	450	327	16	10	8
20.5 R25	4000	3870	3070	2530	1872	450	327	16	10	8

** Lowered • Abgesenkt • Surbaissée • Rebaja • Abbassato • Спущенный

Dimensions • Abmessungen • Encombrement Dimensiones • Dimensioni • Размеры

Counterweight • Gegengewicht • Contrepoids • Contrapesos • Contrappesi • Противовес

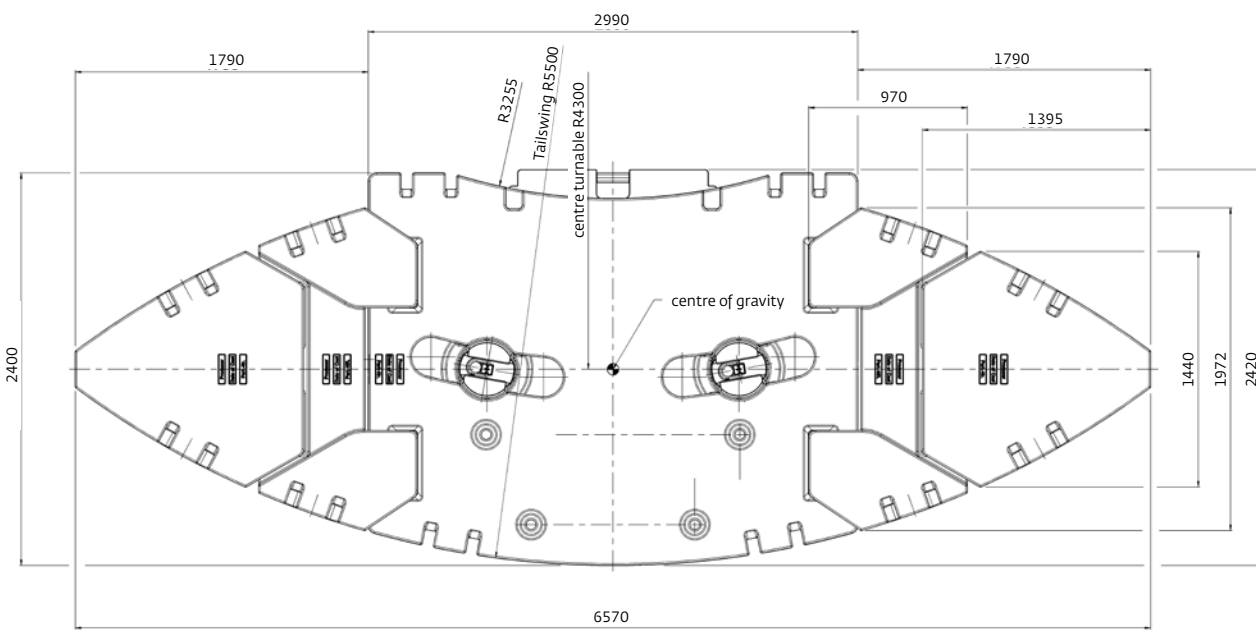
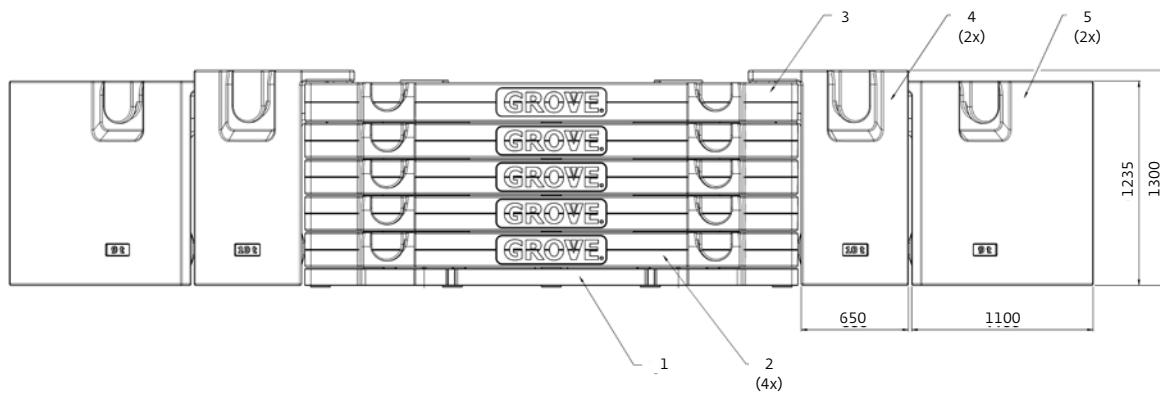

	1 7,0 t	2 9,5 t	3 9,5 t	4 10,0 t	5 9,0 t
7,0 t	x	-	-	-	-
16,5 t	x	x	-	-	-
26,0 t	x	2 x	-	-	-
35,5 t	x	3 x	-	-	-
45,0 t	x	4 x	-	-	-
54,5 t	x	4 x	x	-	-
74,5 t	x	4 x	x	2 x	-
92,5 t	x	4 x	x	2 x	2 x

Data • Daten • Caractéristiques • Datos • Dati • Данные



Axle • Achse Essieu • Eje Asse • Оси	1	2	3	4	5	6	Total weight • Gesamtgewicht Poids total • Peso total Peso totale • Суммарный вес
t	12	12	12	12	12	12	72 *

* with 0 t counterweight, 12x6x12, hydraulic retarder, 32 t hookblock • mit 0 t Gegengewicht, 12x6x12, hydraulischer Retarder, 32 t Hakenflasche • avec contrepois de 0 t, 12x6x12, pneus, ralentisseur hydraulique, moufle de 32 t • con 0 t contrapeso, 12x6x12, retardador hidráulico, gancho de 32 t • con a bordo 0 t di zavorra, 12x6x12, retarder idraulico, gancio da 32 t • с противовесом (0 т), 12x6x12, гидравлический замедлитель, крюковым блоком (32 т).



Lifting Capacity Traglast Force de levage Capacidad de elevación Capacità di sollevamento Грузоподъемность	Sheaves Rollen Poulies Poleas Carrucolo Шкивы	Weight Gewicht Poids Peso Peso Масса	Parts of line Stränge Brins Ramales de cable Numero di funi Кратность запасовки	Possible load with crane Mögliche Traglast am Kran Capacité possible sur la grue Carga posible con la grue Portata ammissibile con la gru Допустимая нагрузка для крана
200 t	9	2400 kg	2 - 18 / ■19	179 t / 190 t■
160 t	7	1750 kg	2 - 15	135 t
125 t	5	1650 kg	2 - 11	100 t
80 t	3	950 kg	1 - 7	65 t
32 t	1	600 kg	1 - 3	28 t
12 t	H/B	300 kg	1	9,5 t

■ Requires additional boom nose sheave • Zusatzausrüstung am Rollenkopf erforderlich • Demande d'utiliser une poulie auxiliaire de tête de fleche • Requiere polea adicional en la cabeza de pluma • E' richiesta una carrucola addizionale sulla testa del braccio • требует наличия дополнительного шкива в оголовке стрелы

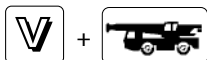

	1	2	3	4	5	6	R		
Tier 3	km/h	16,6	35,2	50,9	77,9	85,0	85,0	14,0	48,7 %
	km/h	7,5	15,9	23,0	35,1	46,2	52,5	6,3	
Tier 4 final	km/h	9,2	24,1	35,4	55,0	73,1	85,0	11,6	53,6 %
	km/h	4,2	10,9	16,0	24,8	33,0	38,0	5,2	
	385/95 R25								

* Theoretical gradeability • Theoretisches Steigvermögen • Aptitude théorique en pente • Inclinação teórica • Pendenza teorica • Преодолеваемый уклон (теор.)

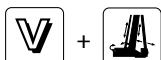

	Infinitely variable • Stufenlos Progressivment variable Infinitamente variable • Infinitamente variable Плавно-изменяемый	Rope • Seil Câble Cable • Fune Канат	Max. Single line pull • Max. Seilzug Effort maxi au brin simple Tiro máximo por ramal • Tiro max. per singola fune • Макс. натяжение каната
	0 - 120 m/min Single line • Einfacher Strang Brin simple • Ramal simple • Tiro a fune singola • Однократная запасовка	22 mm/330 m (350 m)*	104,0 kN (93,5 kN)*
	0 - 120 m/min Single line • Einfacher Strang Brin simple • Ramal simple • Tiro a fune singola • Однократная запасовка	22 mm/330 m (350 m)*	104,0 kN (93,5 kN)*
	0 - 1,3 min ⁻¹		
	-1,5° to + 83° approx. 95 s • ca. 95 s env. 95 s • aproximadamente 95 s aproximadamente 95 s • примерно 95 с		
	15,6 to 80,0 m approx. 760 s • ca. 760 s env. 760 s • aproximadamente 760 s aproximadamente 760 s • примерно 760 с		

* for US/Canada region

Load charts • Traglasten • Capacités de levage Capacidades • Capacità • Таблицы грузоподъемности



Overview • Übersicht • Tableau synoptique • Resumen de las tablas • Tabella riassuntiva • Общие сведения

 15,58 – 80,0 m

 360°

 8,70 x 8,50 m



 8,70 x 7,40 m

 m  t	92,5	74,5	54,5	45,0	35,5	26,0	21,2	16,5	7,0	0	92,5	74,5	54,5	45,0	35,5	26,0	21,2	16,5	7,0	0	
15,58
20,93
26,24
31,52
36,81
42,09
47,53
52,87
58,41
63,85
69,32
74,77
80,00

 8,70 x 6,30 m

 8,70 x 5,00 m

 8,70 x 2,71 m

 m  t	92,5	74,5	54,5	45,0	35,5	26,0	21,2	16,5	7,0	0	54,5	45,0	35,5	26,0	21,2	16,5	7,0	0	7,0	0	
15,58
20,93
26,24
31,52
36,81
42,09
47,53
52,87
58,41
63,85
69,32
74,77
80,00

 5°-40°
12,0 - 21,0 - 29,0 - 37,0 m

 360°
 8,70 x 8,50 m



 92,5 t

 74,5 t

 54,5 t

 45,0 t

 35,5 t

 m  m	12	21	29	37	12	21	29	37	12	21	29	37	12	21	29	37	12	21	
47,53
52,87
58,41
63,85
69,32
74,77
80,00

 8,70 x 7,40 m

 8,70 x 6,30 m

 92,5 t

 74,5 t



 54,5 t

 45,0 t

 92,5 t

 74,5 t

 54,5 t

 m  m	12	21	29	37	12	21	26	34	12	21	26	34	12	21	12	21	29	37	12	21	29	37	12	21	
47,53
52,87
58,41
63,85
69,32
74,77
80,00

Load charts • Traglasten • Capacités de levage Capacidades • Capacità • Таблицы грузоподъемности

Working range • Arbeitsbereiche • Diagramme de levage • Gama de trabajo • Area di lavoro • Грузовысотные характеристики



15,6 – 80,0 m



8,5 m



360°

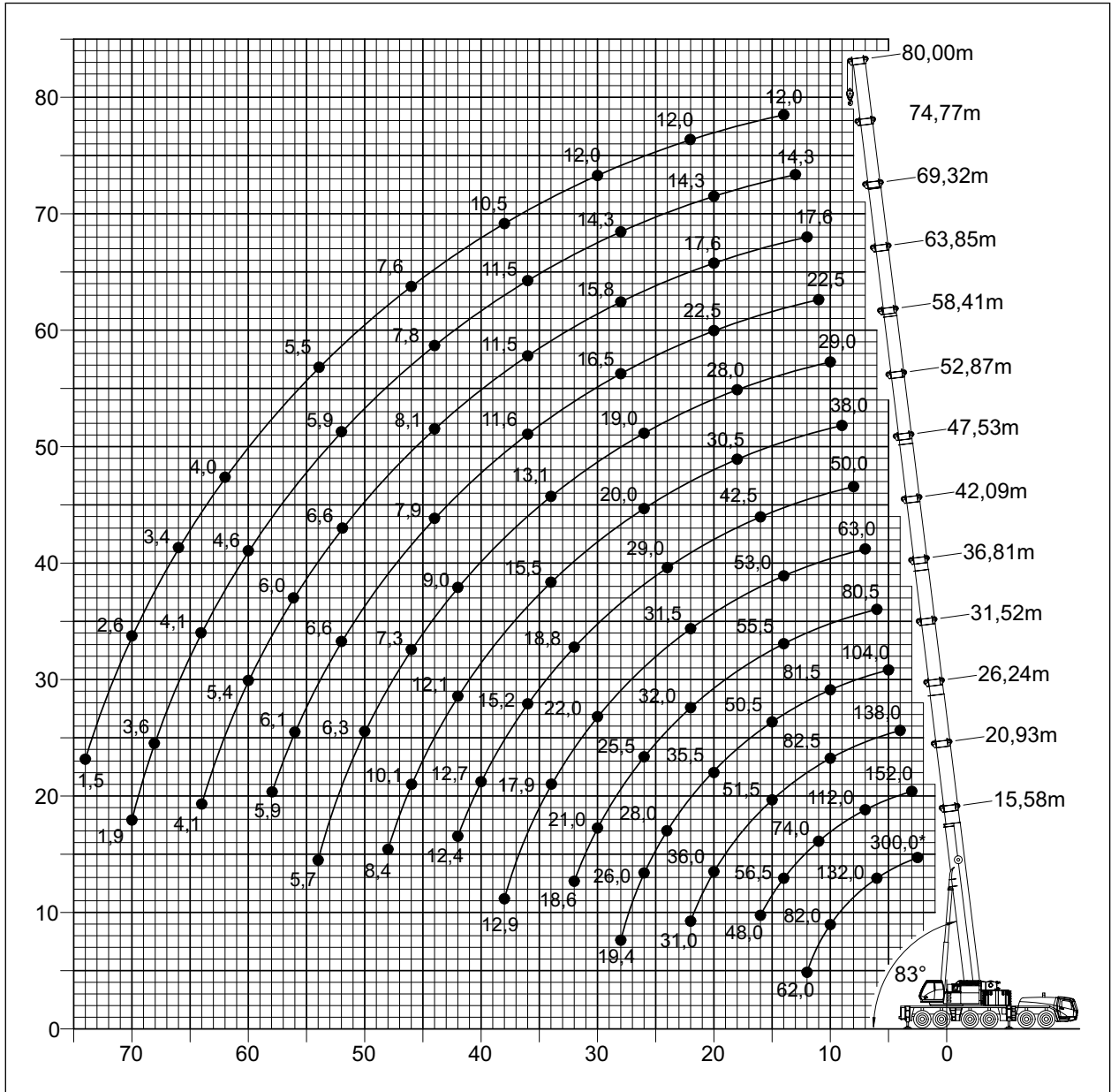

Hook block • Hakenflasche • Crochet-moufle • Gancho • Ganci • Крюковой блок	H (mm)
200 D	3650
160 D	3650
125 D	3300
80 D	3300
32 E	3200
12 H/B	2450

* Over rear • Nach hinten • En arrière • Por la parte trasera • Sul posteriore • Над задней частью

Load charts • Traglasten • Capacités de levage Capacidades • Capacità • Таблицы грузоподъемности

Telescopic boom • Teleskopausleger • Flèche principale • Pluma telescópica
Braccio telescopico • Телескопическая стрела



15,6 - 80,0 m



8,5 m



360°



92,5 t



EN 13000

m	15,58*	15,58	20,93	26,24	31,52	36,81	42,09	47,53	52,87	58,41	63,85	69,32	74,77	80,00	m
2,5	300,0**	-	-	-	-	-	-	-	-	-	-	-	-	-	2,5
3,0	190,0	190,0	152,0	-	-	-	-	-	-	-	-	-	-	-	3,0
4,0	169,0	165,0	152,0	138,0	-	-	-	-	-	-	-	-	-	-	4,0
5,0	149,0	144,0	140,0	132,0	104,0	-	-	-	-	-	-	-	-	-	5,0
6,0	132,0	127,0	126,0	118,0	104,0	80,5	-	-	-	-	-	-	-	-	6,0
7,0	118,0	113,0	112,0	108,0	104,0	80,5	63,0	-	-	-	-	-	-	-	7,0
8,0	105,0	102,0	102,0	99,0	95,0	80,5	63,0	50,0	-	-	-	-	-	-	8,0
9,0	92,5	91,5	92,0	90,0	88,0	80,0	63,0	50,0	38,0	-	-	-	-	-	9,0
10,0	82,0	82,0	82,5	82,5	81,5	75,5	63,0	50,0	38,0	29,0	-	-	-	-	10,0
11,0	73,5	73,5	74,0	74,0	73,0	71,5	61,5	50,0	38,0	29,0	22,5	-	-	-	11,0
12,0	62,0	62,0	67,0	66,5	66,0	67,0	58,5	48,5	38,0	29,0	22,5	17,6	-	-	12,0
13,0	-	-	61,0	60,5	60,0	61,0	55,5	47,0	38,0	29,0	22,5	17,6	14,3	-	13,0
14,0	-	-	56,5	55,5	54,5	55,5	53,0	45,5	37,5	29,0	22,5	17,6	14,3	12,0	14,0
15,0	-	-	52,0	51,5	50,5	51,0	50,5	44,0	35,5	29,0	22,5	17,6	14,3	12,0	15,0
16,0	-	-	48,0	48,5	47,5	47,0	48,0	42,5	33,5	29,0	22,5	17,6	14,3	12,0	16,0
18,0	-	-	-	41,5	41,0	40,0	41,5	39,0	30,5	28,0	22,5	17,6	14,3	12,0	18,0
20,0	-	-	-	36,0	35,5	35,0	36,0	36,0	27,0	25,5	22,5	17,6	14,3	12,0	20,0
22,0	-	-	-	31,0	31,5	32,0	31,5	32,5	24,5	23,0	21,5	17,6	14,3	12,0	22,0
24,0	-	-	-	-	28,0	29,0	28,0	29,0	22,5	21,0	20,0	17,6	14,3	12,0	24,0
26,0	-	-	-	-	26,0	25,5	25,0	26,0	20,0	19,0	18,2	16,9	14,3	12,0	26,0
28,0	-	-	-	-	19,4	23,0	23,5	23,5	18,0	17,0	16,5	15,8	14,3	12,0	28,0
30,0	-	-	-	-	-	21,0	22,0	21,0	17,0	15,6	15,1	14,7	13,8	12,0	30,0
32,0	-	-	-	-	-	18,6	19,8	18,8	16,2	14,2	13,8	13,6	13,0	12,0	32,0
34,0	-	-	-	-	-	-	17,9	16,9	15,5	13,1	12,7	12,6	12,2	11,7	34,0
36,0	-	-	-	-	-	-	16,2	15,2	14,8	11,9	11,6	11,5	11,5	11,1	36,0
38,0	-	-	-	-	-	-	12,9	13,7	14,3	11,0	10,7	10,6	10,7	10,5	38,0
40,0	-	-	-	-	-	-	-	12,7	13,3	10,1	9,8	9,7	9,9	9,5	40,0
42,0	-	-	-	-	-	-	-	12,4	12,1	9,0	8,7	8,7	8,9	8,6	42,0
44,0	-	-	-	-	-	-	-	-	11,1	7,9	7,9	8,1	7,8	8,1	44,0
46,0	-	-	-	-	-	-	-	-	10,1	7,3	7,6	7,7	7,2	7,6	46,0
48,0	-	-	-	-	-	-	-	-	8,4	6,7	7,2	7,3	6,7	7,0	48,0
50,0	-	-	-	-	-	-	-	-	-	6,3	6,9	6,9	6,3	6,5	50,0
52,0	-	-	-	-	-	-	-	-	-	6,0	6,6	6,6	5,9	6,0	52,0
54,0	-	-	-	-	-	-	-	-	-	5,7	6,3	6,3	5,5	5,5	54,0
56,0	-	-	-	-	-	-	-	-	-	-	6,1	6,0	5,2	5,1	56,0
58,0	-	-	-	-	-	-	-	-	-	-	5,9	5,7	4,9	4,7	58,0
60,0	-	-	-	-	-	-	-	-	-	-	-	5,4	4,6	4,4	60,0
62,0	-	-	-	-	-	-	-	-	-	-	-	5,2	4,3	4,0	62,0
64,0	-	-	-	-	-	-	-	-	-	-	-	4,1	4,1	3,7	64,0
66,0	-	-	-	-	-	-	-	-	-	-	-	-	3,8	3,4	66,0
68,0	-	-	-	-	-	-	-	-	-	-	-	-	3,6	3,0	68,0
70,0	-	-	-	-	-	-	-	-	-	-	-	-	1,9	2,6	70,0
72,0	-	-	-	-	-	-	-	-	-	-	-	-	-	2,3	72,0
74,0	-	-	-	-	-	-	-	-	-	-	-	-	-	1,5	74,0

* 0° over rear • nach hinten • en arrière • por la parte trasera • sul posteriore • Над задней частью

** 0° over rear with special equipment • Nach hinten mit Zusatzeinrichtung • En arrière avec équipement supplémentaires • Por la parte trasera con equipo adicional • Sull'antieriore con equipaggiamento ausiliario • Над задней частью с специальным оборудованием

Load charts • Traglasten • Capacités de levage Capacidades • Capacità • Таблицы грузоподъемности

Telescopic boom • Teleskopausleger • Flèche principale • Pluma telescópica
Braccio telescopico • Телескопическая стрела



15,6 - 80,0 m



8,5 m



360°



74,5 t



EN 13000

m	15,58	20,93	26,24	31,52	36,81	42,09	47,53	52,87	58,41	63,85	69,32	74,77	80,00	m
3,0	190,0	152,0	-	-	-	-	-	-	-	-	-	-	-	3,0
4,0	163,0	152,0	138,0	-	-	-	-	-	-	-	-	-	-	4,0
5,0	142,0	140,0	132,0	104,0	-	-	-	-	-	-	-	-	-	5,0
6,0	125,0	124,0	118,0	104,0	80,5	-	-	-	-	-	-	-	-	6,0
7,0	111,0	111,0	108,0	104,0	80,5	63,0	-	-	-	-	-	-	-	7,0
8,0	97,5	98,5	98,0	95,0	80,5	63,0	50,0	-	-	-	-	-	-	8,0
9,0	85,5	86,0	86,0	85,0	80,0	63,0	50,0	38,0	-	-	-	-	-	9,0
10,0	76,0	76,5	76,0	75,5	75,5	63,0	50,0	38,0	29,0	-	-	-	-	10,0
11,0	68,0	69,5	68,5	67,5	68,5	61,5	50,0	38,0	29,0	22,5	-	-	-	11,0
12,0	61,0	62,5	62,0	61,5	61,5	58,5	48,5	38,0	29,0	22,5	17,6	-	-	12,0
13,0	-	56,5	57,0	56,5	55,5	55,5	47,0	38,0	29,0	22,5	17,6	14,3	-	13,0
14,0	-	51,5	52,0	51,5	50,5	51,5	45,5	37,5	29,0	22,5	17,6	14,3	12,0	14,0
15,0	-	47,0	47,5	47,0	46,0	47,0	44,0	35,5	29,0	22,5	17,6	14,3	12,0	15,0
16,0	-	43,0	43,5	43,0	43,0	43,5	42,5	33,5	29,0	22,5	17,6	14,3	12,0	16,0
18,0	-	-	37,5	37,0	38,0	37,0	38,0	30,5	28,0	22,5	17,6	14,3	12,0	18,0
20,0	-	-	32,5	33,5	33,0	32,0	33,0	27,0	25,5	22,5	17,6	14,3	12,0	20,0
22,0	-	-	27,5	29,0	28,5	29,0	28,5	24,5	23,0	21,5	17,6	14,3	12,0	22,0
24,0	-	-	-	25,0	24,5	26,0	25,0	22,5	21,0	20,0	17,6	14,3	12,0	24,0
26,0	-	-	-	22,0	22,5	22,5	21,5	20,0	19,0	18,2	16,9	14,3	12,0	26,0
28,0	-	-	-	19,4	20,5	20,0	19,0	18,0	17,0	16,5	15,8	14,3	12,0	28,0
30,0	-	-	-	-	18,5	17,8	16,8	17,0	15,6	15,1	14,7	13,8	12,0	30,0
32,0	-	-	-	-	16,6	15,9	15,0	15,8	13,8	13,8	13,6	13,0	12,0	32,0
34,0	-	-	-	-	-	14,2	14,4	14,1	12,1	12,2	12,6	12,2	11,7	34,0
36,0	-	-	-	-	-	12,8	13,7	12,7	10,6	10,8	11,2	11,5	11,1	36,0
38,0	-	-	-	-	-	12,2	12,4	11,4	9,4	9,8	10,3	10,5	10,5	38,0
40,0	-	-	-	-	-	-	11,3	10,2	8,2	9,1	9,4	9,3	9,5	40,0
42,0	-	-	-	-	-	-	10,2	9,2	7,6	8,3	8,6	8,3	8,6	42,0
44,0	-	-	-	-	-	-	-	8,3	7,3	7,9	8,1	7,6	7,9	44,0
46,0	-	-	-	-	-	-	-	7,5	6,9	7,6	7,7	7,1	7,1	46,0
48,0	-	-	-	-	-	-	-	6,7	6,6	7,2	7,3	6,7	6,3	48,0
50,0	-	-	-	-	-	-	-	-	6,3	6,7	6,7	6,3	5,6	50,0
52,0	-	-	-	-	-	-	-	-	6,0	6,1	6,0	5,7	5,0	52,0
54,0	-	-	-	-	-	-	-	-	5,7	5,5	5,4	5,1	4,4	54,0
56,0	-	-	-	-	-	-	-	-	-	5,0	4,9	4,5	3,8	56,0
58,0	-	-	-	-	-	-	-	-	-	4,5	4,4	4,0	3,3	58,0
60,0	-	-	-	-	-	-	-	-	-	-	4,0	3,6	2,9	60,0
62,0	-	-	-	-	-	-	-	-	-	-	3,7	3,1	2,4	62,0
64,0	-	-	-	-	-	-	-	-	-	-	3,3	2,7	2,0	64,0
66,0	-	-	-	-	-	-	-	-	-	-	-	2,4	1,6	66,0
68,0	-	-	-	-	-	-	-	-	-	-	-	2,0	1,3	68,0
70,0	-	-	-	-	-	-	-	-	-	-	-	1,7	-	70,0

Load charts • Traglasten • Capacités de levage Capacidades • Capacità • Таблицы грузоподъемности

Telescopic boom • Teleskopausleger • Flèche principale • Pluma telescópica
Braccio telescopico • Телескопическая стрела



15,6 - 80,0 m



8,5 m



360°



54,5 t



EN 13000

m	15,58	20,93	26,24	31,52	36,81	42,09	47,53	52,87	58,41	63,85	69,32	74,77	80,00	m
3,0	188,0	152,0	-	-	-	-	-	-	-	-	-	-	-	3,0
4,0	160,0	152,0	138,0	-	-	-	-	-	-	-	-	-	-	4,0
5,0	139,0	139,0	132,0	104,0	-	-	-	-	-	-	-	-	-	5,0
6,0	121,0	121,0	118,0	104,0	80,5	-	-	-	-	-	-	-	-	6,0
7,0	104,0	104,0	104,0	103,0	80,5	63,0	-	-	-	-	-	-	-	7,0
8,0	89,5	90,0	89,5	88,5	80,5	63,0	50,0	-	-	-	-	-	-	8,0
9,0	77,5	79,5	78,0	77,0	75,5	63,0	50,0	38,0	-	-	-	-	-	9,0
10,0	68,0	69,5	70,0	69,5	66,0	63,0	50,0	38,0	29,0	-	-	-	-	10,0
11,0	60,0	61,5	62,0	61,5	59,5	57,0	50,0	38,0	29,0	22,5	-	-	-	11,0
12,0	54,0	55,5	55,5	55,5	55,0	51,0	48,5	38,0	29,0	22,5	17,6	-	-	12,0
13,0	-	50,0	50,5	50,0	49,5	46,0	46,0	38,0	29,0	22,5	17,6	14,3	-	13,0
14,0	-	46,0	45,5	46,0	45,0	41,5	42,0	37,5	29,0	22,5	17,6	14,3	12,0	14,0
15,0	-	41,0	40,5	42,0	41,0	39,5	38,0	35,5	29,0	22,5	17,6	14,3	12,0	15,0
16,0	-	36,5	36,5	38,0	37,5	37,5	35,0	32,5	29,0	22,5	17,6	14,3	12,0	16,0
18,0	-	-	31,0	31,0	31,0	32,0	30,0	27,5	26,5	22,5	17,6	14,3	12,0	18,0
20,0	-	-	26,0	26,0	27,5	27,0	25,5	24,0	23,0	22,0	17,6	14,3	12,0	20,0
22,0	-	-	22,0	22,5	23,5	23,0	22,0	21,5	19,7	19,2	17,6	14,3	12,0	22,0
24,0	-	-	-	20,5	20,5	19,7	18,7	19,7	17,0	16,6	16,8	14,3	12,0	24,0
26,0	-	-	-	18,0	17,8	17,1	17,6	17,1	14,8	14,5	14,6	14,3	12,0	26,0
28,0	-	-	-	15,8	15,6	15,2	16,0	14,9	12,8	13,2	13,6	13,7	12,0	28,0
30,0	-	-	-	-	13,8	14,5	14,1	13,0	11,6	12,4	12,8	12,9	11,9	30,0
32,0	-	-	-	-	12,4	13,2	12,5	11,4	10,8	11,6	12,1	11,7	10,5	32,0
34,0	-	-	-	-	-	11,8	11,1	10,1	10,2	10,8	10,8	10,4	9,3	34,0
36,0	-	-	-	-	-	10,5	9,9	8,8	9,6	10,1	9,8	9,2	8,2	36,0
38,0	-	-	-	-	-	9,5	8,8	7,8	8,5	9,3	8,6	8,2	7,3	38,0
40,0	-	-	-	-	-	-	7,8	6,8	8,1	8,4	7,8	7,2	6,4	40,0
42,0	-	-	-	-	-	-	7,0	6,0	7,6	7,5	6,9	6,3	5,6	42,0
44,0	-	-	-	-	-	-	-	5,2	6,8	6,7	6,1	5,6	4,8	44,0
46,0	-	-	-	-	-	-	-	4,5	6,3	6,0	5,4	4,9	4,1	46,0
48,0	-	-	-	-	-	-	-	3,9	5,7	5,4	4,8	4,2	3,5	48,0
50,0	-	-	-	-	-	-	-	-	5,1	4,8	4,2	3,6	2,9	50,0
52,0	-	-	-	-	-	-	-	-	4,6	4,2	3,7	3,1	2,3	52,0
54,0	-	-	-	-	-	-	-	-	4,1	3,7	3,2	2,6	1,7	54,0
56,0	-	-	-	-	-	-	-	-	-	3,3	2,7	2,1	1,2	56,0
58,0	-	-	-	-	-	-	-	-	-	2,9	2,3	1,6	-	58,0
60,0	-	-	-	-	-	-	-	-	-	-	1,8	-	-	60,0
62,0	-	-	-	-	-	-	-	-	-	-	1,4	-	-	62,0

Load charts • Traglasten • Capacités de levage Capacidades • Capacità • Таблицы грузоподъемности

Telescopic boom • Teleskopausleger • Flèche principale • Pluma telescópica
Braccio telescopico • Телескопическая стрела



15,6 - 80,0 m



8,5 m



360°



45,0 t



EN 13000

m	15,58	20,93	26,24	31,52	36,81	42,09	47,53	52,87	58,41	63,85	69,32	74,77	80,00	m
3,0	187,0	152,0	-	-	-	-	-	-	-	-	-	-	-	3,0
4,0	159,0	152,0	138,0	-	-	-	-	-	-	-	-	-	-	4,0
5,0	137,0	137,0	132,0	104,0	-	-	-	-	-	-	-	-	-	5,0
6,0	117,0	117,0	116,0	104,0	80,5	-	-	-	-	-	-	-	-	6,0
7,0	99,0	99,5	99,5	97,5	80,5	63,0	-	-	-	-	-	-	-	7,0
8,0	85,0	85,5	85,0	82,0	78,0	63,0	50,0	-	-	-	-	-	-	8,0
9,0	73,0	75,0	75,0	72,5	68,0	63,0	50,0	38,0	-	-	-	-	-	9,0
10,0	64,0	65,5	66,0	63,0	61,5	57,0	50,0	38,0	29,0	-	-	-	-	10,0
11,0	56,5	58,0	58,5	55,5	54,5	50,5	50,0	38,0	29,0	22,5	-	-	-	11,0
12,0	49,5	52,0	52,0	51,5	48,5	45,0	44,5	38,0	29,0	22,5	17,6	-	-	12,0
13,0	-	46,0	45,5	46,0	43,5	42,5	40,5	37,5	29,0	22,5	17,6	14,3	-	13,0
14,0	-	40,5	40,0	41,5	39,5	39,5	36,5	34,0	29,0	22,5	17,6	14,3	12,0	14,0
15,0	-	36,0	37,0	37,0	36,0	36,0	33,5	31,0	29,0	22,5	17,6	14,3	12,0	15,0
16,0	-	32,0	33,0	33,5	34,0	33,0	30,5	28,0	27,0	22,5	17,6	14,3	12,0	16,0
18,0	-	-	27,0	27,0	28,5	28,0	26,0	24,5	22,5	22,0	17,6	14,3	12,0	18,0
20,0	-	-	24,0	24,5	24,0	23,5	22,0	22,5	19,3	18,8	17,6	14,3	12,0	20,0
22,0	-	-	20,0	20,5	20,5	19,8	20,0	19,6	16,4	16,2	16,2	14,3	12,0	22,0
24,0	-	-	-	17,8	17,6	17,1	18,0	16,9	14,2	15,0	15,2	14,3	12,0	24,0
26,0	-	-	-	15,5	15,2	16,2	15,6	14,5	13,3	14,1	14,4	13,8	12,0	26,0
28,0	-	-	-	13,5	13,8	14,3	13,6	12,5	12,3	13,2	13,2	12,2	11,0	28,0
30,0	-	-	-	-	12,9	12,6	11,9	10,9	11,6	12,2	11,8	10,8	9,6	30,0
32,0	-	-	-	-	11,4	11,1	10,4	9,4	10,8	11,0	10,4	9,5	8,4	32,0
34,0	-	-	-	-	-	9,9	9,2	8,2	9,8	9,8	9,2	8,4	7,3	34,0
36,0	-	-	-	-	-	8,8	8,1	7,1	8,7	8,6	8,1	7,4	6,3	36,0
38,0	-	-	-	-	-	8,0	7,1	6,1	7,9	7,6	7,1	6,5	5,4	38,0
40,0	-	-	-	-	-	-	6,5	5,2	7,1	6,8	6,2	5,6	4,6	40,0
42,0	-	-	-	-	-	-	6,1	4,4	6,3	6,0	5,4	4,8	3,9	42,0
44,0	-	-	-	-	-	-	-	3,7	5,6	5,3	4,7	4,1	3,2	44,0
46,0	-	-	-	-	-	-	-	3,0	4,9	4,6	4,1	3,4	2,5	46,0
48,0	-	-	-	-	-	-	-	2,4	4,4	4,0	3,4	2,7	1,9	48,0
50,0	-	-	-	-	-	-	-	-	3,8	3,5	2,8	2,2	1,3	50,0
52,0	-	-	-	-	-	-	-	-	3,3	3,0	2,3	1,6	-	52,0
54,0	-	-	-	-	-	-	-	-	2,9	2,5	1,8	-	-	54,0
56,0	-	-	-	-	-	-	-	-	-	2,0	1,4	-	-	56,0
58,0	-	-	-	-	-	-	-	-	-	1,6	-	-	-	58,0

Load charts • Traglasten • Capacités de levage Capacidades • Capacità • Таблицы грузоподъемности

Telescopic boom • Teleskopausleger • Flèche principale • Pluma telescópica
Braccio telescopico • Телескопическая стрела



15,6 - 80,0 m



8,5 m



360°



35,5 t



EN 13000

m	15,58	20,93	26,24	31,52	36,81	42,09	47,53	52,87	58,41	63,85	69,32	74,77	80,00	m
3,0	185,0	152,0	-	-	-	-	-	-	-	-	-	-	-	3,0
4,0	158,0	152,0	138,0	-	-	-	-	-	-	-	-	-	-	4,0
5,0	135,0	134,0	132,0	104,0	-	-	-	-	-	-	-	-	-	5,0
6,0	112,0	112,0	112,0	104,0	80,5	-	-	-	-	-	-	-	-	6,0
7,0	94,5	95,0	94,5	85,5	80,5	63,0	-	-	-	-	-	-	-	7,0
8,0	79,5	80,5	80,5	74,5	71,5	63,0	50,0	-	-	-	-	-	-	8,0
9,0	68,5	70,0	68,5	64,0	61,5	56,5	50,0	38,0	-	-	-	-	-	9,0
10,0	60,0	61,5	59,0	57,5	53,5	49,5	48,5	38,0	29,0	-	-	-	-	10,0
11,0	50,5	53,5	51,5	50,5	47,0	46,5	43,0	38,0	29,0	22,5	-	-	-	11,0
12,0	43,0	46,0	45,5	45,0	42,0	42,0	38,5	35,5	29,0	22,5	17,6	-	-	12,0
13,0	-	40,0	41,0	40,0	40,0	37,5	34,5	32,0	29,0	22,5	17,6	14,3	-	13,0
14,0	-	35,0	36,0	36,0	36,5	34,0	31,5	29,0	27,5	22,5	17,6	14,3	12,0	14,0
15,0	-	31,0	32,0	32,0	33,0	31,0	28,5	27,5	25,0	22,5	17,6	14,3	12,0	15,0
16,0	-	27,5	28,5	30,0	30,0	28,5	26,0	26,5	22,5	22,0	17,6	14,3	12,0	16,0
18,0	-	-	24,5	25,0	25,0	24,0	23,0	22,0	18,8	18,7	17,6	14,3	12,0	18,0
20,0	-	-	20,5	21,0	20,5	20,0	21,0	19,0	16,6	17,3	17,2	14,3	12,0	20,0
22,0	-	-	17,1	17,6	17,4	18,5	17,8	16,3	15,4	16,2	16,0	14,3	12,0	22,0
24,0	-	-	-	15,0	15,5	15,9	15,2	14,0	14,2	14,7	14,0	12,8	11,5	24,0
26,0	-	-	-	13,0	14,0	13,7	13,0	12,0	13,3	13,3	12,2	11,1	9,9	26,0
28,0	-	-	-	12,0	12,2	11,9	11,2	10,1	12,1	11,7	10,6	9,6	8,4	28,0
30,0	-	-	-	-	10,7	10,9	9,7	8,6	10,6	10,3	9,3	8,3	7,2	30,0
32,0	-	-	-	-	9,3	9,8	8,4	7,3	9,2	8,9	8,1	7,2	6,0	32,0
34,0	-	-	-	-	-	8,7	7,9	6,1	8,1	7,8	7,1	6,1	5,1	34,0
36,0	-	-	-	-	-	7,7	7,3	5,1	7,0	6,7	6,1	5,2	4,2	36,0
38,0	-	-	-	-	-	6,8	6,7	4,1	6,1	5,8	5,3	4,4	3,4	38,0
40,0	-	-	-	-	-	-	5,9	3,3	5,4	5,1	4,4	3,7	2,7	40,0
42,0	-	-	-	-	-	-	5,2	2,6	4,6	4,3	3,7	3,0	2,0	42,0
44,0	-	-	-	-	-	-	-	1,9	4,0	3,7	3,0	2,3	1,5	44,0
46,0	-	-	-	-	-	-	-	1,3	3,4	3,0	2,4	1,7	-	46,0
48,0	-	-	-	-	-	-	-	-	2,8	2,5	1,8	-	-	48,0
50,0	-	-	-	-	-	-	-	-	2,3	1,9	1,3	-	-	50,0
52,0	-	-	-	-	-	-	-	-	1,9	1,5	-	-	-	52,0
54,0	-	-	-	-	-	-	-	-	1,5	-	-	-	-	54,0

Load charts • Traglasten • Capacités de levage Capacidades • Capacità • Таблицы грузоподъемности

Telescopic boom • Teleskopausleger • Flèche principale • Pluma telescópica
Braccio telescopico • Телескопическая стрела



15,6 - 80,0 m



8,5 m



360°



26,0 t



EN 13000

m	15,58	20,93	26,24	31,52	36,81	42,09	47,53	52,87	58,41	63,85	69,32	74,77	80,00	m
3,0	184,0	152,0	-	-	-	-	-	-	-	-	-	-	-	3,0
4,0	156,0	152,0	138,0	-	-	-	-	-	-	-	-	-	-	4,0
5,0	130,0	129,0	129,0	104,0	-	-	-	-	-	-	-	-	-	5,0
6,0	107,0	106,0	103,0	91,0	80,5	-	-	-	-	-	-	-	-	6,0
7,0	88,5	89,0	82,0	77,0	73,5	63,0	-	-	-	-	-	-	-	7,0
8,0	74,5	74,5	69,5	67,0	61,5	56,0	50,0	-	-	-	-	-	-	8,0
9,0	63,0	63,5	58,5	57,0	52,5	51,0	47,5	38,0	-	-	-	-	-	9,0
10,0	51,0	54,0	52,0	49,0	46,0	45,0	41,5	38,0	29,0	-	-	-	-	10,0
11,0	42,5	45,5	45,5	43,0	43,0	40,0	36,5	33,5	29,0	22,5	-	-	-	11,0
12,0	36,0	39,0	40,0	38,5	38,0	35,5	32,5	31,0	28,0	22,5	17,6	-	-	12,0
13,0	-	33,5	35,0	36,0	34,0	32,0	29,0	29,0	25,0	22,5	17,6	14,3	-	13,0
14,0	-	29,5	31,5	32,5	31,0	28,5	27,0	26,5	22,5	21,5	17,6	14,3	12,0	14,0
15,0	-	26,0	28,5	29,0	28,0	26,0	26,0	24,0	21,0	21,0	17,6	14,3	12,0	15,0
16,0	-	23,5	25,5	26,0	25,5	23,5	24,0	21,5	20,0	20,5	17,3	14,3	12,0	16,0
18,0	-	-	20,5	21,0	21,0	21,5	20,0	18,0	18,1	18,1	17,1	14,3	12,0	18,0
20,0	-	-	16,7	17,3	17,8	18,2	16,9	15,0	16,6	16,0	15,8	13,5	12,0	20,0
22,0	-	-	13,8	14,8	15,6	15,2	14,4	12,6	14,6	13,7	12,6	11,4	10,1	22,0
24,0	-	-	-	13,0	13,2	13,5	12,1	10,6	12,6	11,8	10,8	9,7	8,4	24,0
26,0	-	-	-	11,0	11,2	11,8	11,2	8,9	10,9	10,2	9,2	8,2	7,0	26,0
28,0	-	-	-	9,4	9,8	10,1	10,1	7,5	9,5	8,8	7,9	6,9	5,7	28,0
30,0	-	-	-	-	8,4	8,8	8,7	6,1	8,1	7,6	6,7	5,7	4,6	30,0
32,0	-	-	-	-	7,3	7,6	7,5	4,9	7,0	6,6	5,7	4,8	3,7	32,0
34,0	-	-	-	-	-	6,6	6,5	3,8	6,0	5,6	4,8	3,9	2,8	34,0
36,0	-	-	-	-	-	5,7	5,6	2,9	5,1	4,7	4,0	3,1	2,1	36,0
38,0	-	-	-	-	-	4,9	4,8	2,1	4,2	3,9	3,2	2,4	1,4	38,0
40,0	-	-	-	-	-	-	4,1	1,4	3,5	3,1	2,5	1,8	-	40,0
42,0	-	-	-	-	-	-	3,5	-	2,8	2,5	1,8	-	-	42,0
44,0	-	-	-	-	-	-	-	-	2,2	1,9	1,2	-	-	44,0
46,0	-	-	-	-	-	-	-	-	1,7	1,3	-	-	-	46,0
48,0	-	-	-	-	-	-	-	-	1,2	-	-	-	-	48,0

Load charts • Traglasten • Capacités de levage Capacidades • Capacità • Таблицы грузоподъемности

Telescopic boom • Teleskopausleger • Flèche principale • Pluma telescópica
Braccio telescopico • Телескопическая стрела

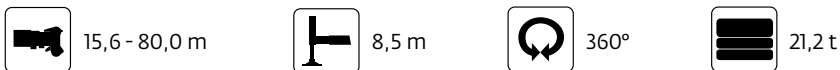

m	15,58	20,93	26,24	31,52	36,81	42,09	47,53	52,87	58,41	63,85	69,32	74,77	80,00	m
3,0	183,0	152,0	-	-	-	-	-	-	-	-	-	-	-	3,0
4,0	154,0	152,0	138,0	-	-	-	-	-	-	-	-	-	-	4,0
5,0	127,0	127,0	121,0	104,0	-	-	-	-	-	-	-	-	-	5,0
6,0	104,0	104,0	94,5	83,5	78,5	-	-	-	-	-	-	-	-	6,0
7,0	85,5	82,5	77,5	74,0	67,5	61,0	-	-	-	-	-	-	-	7,0
8,0	72,0	70,0	64,0	61,5	56,5	53,5	50,0	-	-	-	-	-	-	8,0
9,0	57,5	58,5	55,5	52,0	49,0	47,5	43,5	38,0	-	-	-	-	-	9,0
10,0	46,5	49,5	48,0	45,0	44,5	41,5	38,0	34,5	29,0	-	-	-	-	10,0
11,0	38,5	42,0	41,5	41,0	39,5	36,5	33,5	32,0	28,5	22,5	-	-	-	11,0
12,0	32,0	35,5	36,5	37,0	35,0	32,5	30,0	29,5	25,0	22,5	17,6	-	-	12,0
13,0	-	30,5	33,0	33,0	31,0	29,0	28,5	26,5	22,0	21,5	17,6	14,3	-	13,0
14,0	-	26,5	29,0	29,5	28,0	25,5	26,0	23,5	21,5	21,5	17,6	14,3	12,0	14,0
15,0	-	24,0	26,0	26,5	25,0	24,5	23,5	21,0	20,5	20,5	16,7	14,3	12,0	15,0
16,0	-	21,0	23,0	23,5	22,5	23,0	21,5	19,1	19,6	19,7	16,5	14,3	12,0	16,0
18,0	-	-	18,2	18,8	19,7	19,4	17,7	15,7	17,6	16,6	15,3	14,0	12,0	18,0
20,0	-	-	14,7	15,8	16,6	16,2	14,9	13,0	14,9	14,1	12,9	11,6	10,3	20,0
22,0	-	-	12,0	13,6	13,8	14,4	13,3	10,8	12,7	12,0	10,8	9,7	8,4	22,0
24,0	-	-	-	11,4	11,8	12,1	12,1	8,9	10,9	10,2	9,1	8,1	6,9	24,0
26,0	-	-	-	9,6	10,0	10,3	10,3	7,4	9,4	8,7	7,7	6,7	5,5	26,0
28,0	-	-	-	8,1	8,5	8,8	8,8	6,0	8,1	7,4	6,5	5,5	4,4	28,0
30,0	-	-	-	-	7,2	7,5	7,5	4,7	6,9	6,3	5,4	4,5	3,4	30,0
32,0	-	-	-	-	6,1	6,4	6,4	3,6	5,8	5,4	4,5	3,5	2,4	32,0
34,0	-	-	-	-	-	5,5	5,4	2,6	4,8	4,5	3,6	2,7	1,6	34,0
36,0	-	-	-	-	-	4,7	4,6	1,8	4,0	3,6	2,9	2,0	-	36,0
38,0	-	-	-	-	-	3,9	3,8	-	3,2	2,9	2,2	1,3	-	38,0
40,0	-	-	-	-	-	-	3,1	-	2,5	2,2	1,5	-	-	40,0
42,0	-	-	-	-	-	-	2,5	-	1,9	1,6	-	-	-	42,0
44,0	-	-	-	-	-	-	-	-	1,4	-	-	-	-	44,0

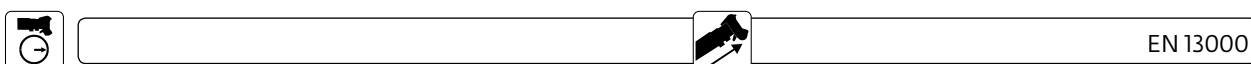
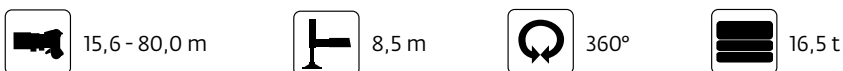

m	15,58	20,93	26,24	31,52	36,81	42,09	47,53	52,87	58,41	63,85	69,32	74,77	80,00	m
3,0	182,0	152,0	-	-	-	-	-	-	-	-	-	-	-	3,0
4,0	153,0	152,0	138,0	-	-	-	-	-	-	-	-	-	-	4,0
5,0	124,0	124,0	112,0	99,5	-	-	-	-	-	-	-	-	-	5,0
6,0	100,0	94,5	86,5	81,0	71,5	-	-	-	-	-	-	-	-	6,0
7,0	82,5	78,5	71,0	68,0	62,0	55,5	-	-	-	-	-	-	-	7,0
8,0	65,5	63,5	60,5	56,0	51,5	50,5	46,0	-	-	-	-	-	-	8,0
9,0	51,0	53,0	51,0	47,5	47,0	43,0	39,5	35,5	-	-	-	-	-	9,0
10,0	41,0	45,0	43,5	43,0	40,5	37,5	34,0	33,0	28,5	-	-	-	-	10,0
11,0	33,5	37,5	37,5	38,0	35,5	33,0	31,5	29,5	25,0	22,5	-	-	-	11,0
12,0	28,0	31,5	34,5	33,5	31,5	29,0	29,0	26,0	22,0	21,5	17,6	-	-	12,0
13,0	-	28,0	30,0	29,5	28,0	27,0	26,0	23,0	22,0	21,5	17,6	14,3	-	13,0
14,0	-	24,0	26,0	26,5	15,0	25,0	23,0	20,5	21,5	20,0	17,2	14,3	12,0	14,0
15,0	-	21,0	23,0	23,5	22,5	22,5	21,0	18,5	20,5	18,1	17,2	14,3	12,0	15,0
16,0	-	18,2	20,5	21,0	21,5	20,5	18,8	16,6	18,5	17,4	16,0	14,3	12,0	16,0
18,0	-	-	16,0	17,2	17,9	17,3	16,0	13,5	15,4	14,5	13,2	11,9	10,5	18,0
20,0	-	-	12,7	14,4	14,6	15,2	14,5	11,0	13,0	12,1	10,9	9,8	8,4	20,0
22,0	-	-	10,4	11,8	12,3	12,6	12,5	8,9	10,9	10,2	9,1	8,0	6,7	22,0
24,0	-	-	-	9,8	10,2	10,5	10,5	7,2	9,3	8,6	7,5	6,4	5,2	24,0
26,0	-	-	-	8,1	8,5	8,9	8,8	5,7	7,8	7,2	6,1	5,1	3,9	26,0
28,0	-	-	-	6,7	7,2	7,5	7,4	4,5	6,6	5,9	5,0	4,0	2,9	28,0
30,0	-	-	-	-	6,0	6,3	6,3	3,4	5,5	4,9	4,0	3,0	1,9	30,0
32,0	-	-	-	-	5,0	5,3	5,2	2,3	4,6	4,0	3,1	2,2	-	32,0
34,0	-	-	-	-	-	4,4	4,3	1,4	3,7	3,2	2,3	1,4	-	34,0
36,0	-	-	-	-	-	3,6	3,5	-	2,9	2,5	1,6	-	-	36,0
38,0	-	-	-	-	-	2,9	2,8	-	2,2	1,8	-	-	-	38,0
40,0	-	-	-	-	-	-	2,2	-	1,5	-	-	-	-	40,0
42,0	-	-	-	-	-	-	1,6	-	-	-	-	-	-	42,0

Load charts • Traglasten • Capacités de levage Capacidades • Capacità • Таблицы грузоподъемности

Telescopic boom • Teleskopausleger • Flèche principale • Pluma telescópica
Braccio telescopico • Телескопическая стрела



15,6 - 58,3 m



8,5 m



360°



7,0 t



EN 13000

m	15,58	20,93	26,24	31,52	36,81	42,09	47,32	58,25	m
3,0	180,0	152,0	-	-	-	-	-	-	3,0
4,0	150,0	148,0	132,0	-	-	-	-	-	4,0
5,0	118,0	109,0	94,5	82,0	-	-	-	-	5,0
6,0	88,5	82,0	74,5	69,0	62,0	-	-	-	6,0
7,0	67,0	64,0	60,0	55,5	53,5	44,5	-	-	7,0
8,0	50,0	51,5	49,0	48,5	45,0	40,5	36,5	-	8,0
9,0	38,5	42,5	41,5	40,5	37,5	34,0	33,5	-	9,0
10,0	30,0	34,0	36,0	34,5	32,0	31,5	29,0	24,0	10,0
11,0	24,0	29,0	30,5	29,5	28,0	27,5	25,0	23,5	11,0
12,0	19,6	24,0	26,5	25,5	26,0	24,0	22,0	21,0	12,0
13,0	-	20,5	22,5	22,5	23,0	22,5	19,3	18,8	13,0
14,0	-	17,2	19,4	21,0	20,5	20,0	17,1	16,7	14,0
15,0	-	14,7	16,8	18,8	18,5	18,0	15,0	14,9	15,0
16,0	-	12,5	14,9	16,6	16,5	16,1	13,3	13,3	16,0
18,0	-	-	11,4	13,0	13,3	13,0	10,4	10,7	18,0
20,0	-	-	8,7	10,2	10,7	10,6	8,2	8,6	20,0
22,0	-	-	6,6	8,0	8,5	8,7	6,4	6,9	22,0
24,0	-	-	-	6,3	6,7	7,1	4,9	5,5	24,0
26,0	-	-	-	4,9	5,3	5,7	3,7	4,3	26,0
28,0	-	-	-	3,7	4,2	4,5	2,7	3,3	28,0
30,0	-	-	-	-	3,2	3,5	1,8	2,4	30,0
32,0	-	-	-	-	2,4	2,7	-	1,7	32,0
34,0	-	-	-	-	-	2,0	-	-	34,0
36,0	-	-	-	-	-	1,4	-	-	36,0



15,6 - 58,3 m



8,5 m



360°



0 t



EN 13000

m	15,58	20,93	26,24	31,52	36,81	42,09	47,32	58,25	m
3,0	178,0	152,0	-	-	-	-	-	-	3,0
4,0	144,0	139,0	112,0	-	-	-	-	-	4,0
5,0	107,0	92,5	82,0	77,0	-	-	-	-	5,0
6,0	74,5	70,0	65,0	58,5	56,0	-	-	-	6,0
7,0	54,0	54,5	51,0	49,5	45,0	40,0	-	-	7,0
8,0	39,0	42,0	42,5	39,5	36,5	35,5	32,0	-	8,0
9,0	29,5	34,5	34,5	32,5	31,5	30,0	27,0	-	9,0
10,0	22,5	27,5	28,5	27,5	27,5	26,5	22,5	21,5	10,0
11,0	17,6	22,5	24,0	25,0	24,0	23,0	19,2	18,4	11,0
12,0	13,7	18,3	20,5	21,0	20,5	19,9	16,4	15,9	12,0
13,0	-	15,1	17,6	18,3	17,8	17,3	14,0	13,8	13,0
14,0	-	12,5	15,0	15,8	15,5	15,1	12,1	12,0	14,0
15,0	-	10,3	12,8	13,8	13,6	13,3	10,4	10,5	15,0
16,0	-	8,5	10,9	12,0	11,9	11,7	9,0	9,2	16,0
18,0	-	-	7,8	9,2	9,3	9,2	6,6	7,0	18,0
20,0	-	-	5,5	6,9	7,2	7,2	4,8	5,3	20,0
22,0	-	-	3,7	5,1	5,6	5,6	3,3	3,9	22,0
24,0	-	-	-	3,7	4,2	4,3	2,1	2,8	24,0
26,0	-	-	-	2,5	3,0	3,2	-	1,8	26,0
28,0	-	-	-	1,6	2,0	2,4	-	-	28,0
30,0	-	-	-	-	1,3	1,6	-	-	30,0

Load charts • Traglasten • Capacités de levage Capacidades • Capacità • Таблицы грузоподъемности

Jib configurations • Kombination der Auslegerverlängerung • Combinaisons de l'extension treillis
Configuración con extensiones de pluma • Combinazioni delle prolunghe del falcone • Конфигурации стрелы

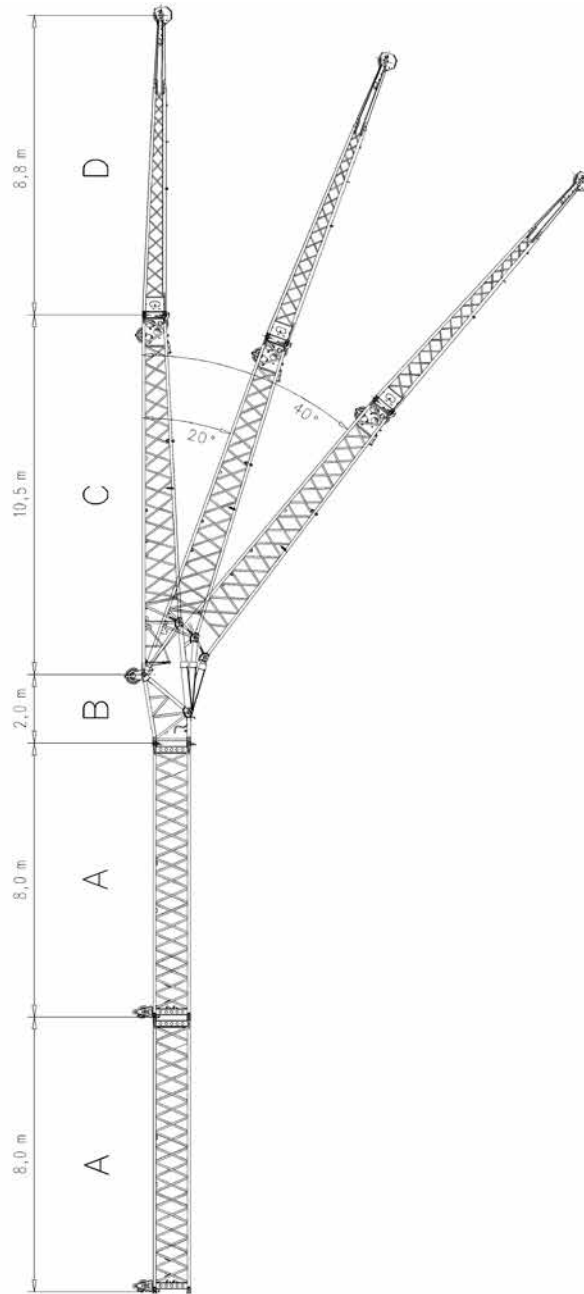

Total Length Gesamtlänge Longueur totale Longitud total Lunghezza Totale Общая длина	Intermediate section boom extension make-up Reihenfolge des Spitzenaufbaus Ordre des combinaisons de l'extension treillis Combinaciones de tramos intermedios de extensión de pluma Sequenza di combinazioni per le sezioni di traliccio del falcone Сборка промежуточной секции гуська крана			
	A 8,0 m	B 2,0 m	C 10,5 m	D 8,8 m
[m]	8,0 m	2,0 m	10,5 m	8,8 m
21,0	-	1x	1x	1x
29,0	1x	1x	1x	1x
37,0	2x	1x	1x	1x

Load charts • Traglasten • Capacités de levage Capacidades • Capacità • Таблицы грузоподъемности

Swingaway (hydraulic luffing) • Klappspitze (hydraulisch wippbar) • Extension treillis (déport hydraulique)
Plumín (angulable hidráulicamente) • Falcone (brandeggio idraulico) • Складной удлинитель стрелы
(гидравлическое изменение вылета)



74,8 - 80,0 m



12,0 m



8,5 m



360°



92,5 t



EN 13000

m	74,8 12,0			80,0 12,0			m
	5°	* 5° - 20°	* 20° - 40°	5°	* 5° - 20°	* 20° - 40°	
16,0	8,4	-	-	-	-	-	16,0
18,0	8,4	-	-	6,8	-	-	18,0
20,0	8,4	8,2	-	6,8	-	-	20,0
22,0	8,4	8,2	7,8	6,8	6,7	6,7	22,0
24,0	8,4	8,2	7,7	6,8	6,7	6,7	24,0
26,0	8,4	8,2	7,6	6,8	6,7	6,7	26,0
28,0	8,4	8,2	7,6	6,8	6,7	6,7	28,0
30,0	8,4	8,2	7,5	6,8	6,7	6,7	30,0
32,0	8,4	8,2	7,4	6,8	6,7	6,7	32,0
34,0	8,4	8,2	7,3	6,8	6,7	6,7	34,0
36,0	8,4	8,1	7,3	6,8	6,7	6,7	36,0
38,0	8,4	8,0	7,2	6,8	6,7	6,7	38,0
40,0	8,2	7,9	7,2	6,8	6,7	6,7	40,0
42,0	7,8	7,7	7,1	6,8	6,7	6,6	42,0
44,0	7,3	7,3	7,1	6,8	6,6	6,4	44,0
46,0	6,9	6,9	7,0	6,5	6,4	6,3	46,0
48,0	6,5	6,5	6,6	6,2	6,2	6,2	48,0
50,0	6,1	6,1	6,2	6,0	6,0	6,0	50,0
52,0	5,7	5,7	5,9	5,6	5,6	5,7	52,0
54,0	5,3	5,3	5,5	5,3	5,3	5,4	54,0
56,0	4,8	4,8	5,1	5,0	5,0	5,1	56,0
58,0	4,5	4,5	4,7	4,7	4,7	4,8	58,0
60,0	4,1	4,1	4,3	4,4	4,4	4,5	60,0
62,0	3,8	3,8	3,9	4,0	4,0	4,2	62,0
64,0	3,5	3,5	3,6	3,7	3,7	3,9	64,0
66,0	3,3	3,3	3,4	3,4	3,4	3,5	66,0
68,0	3,0	3,0	-	3,0	3,0	3,2	68,0
70,0	2,8	2,8	-	2,7	2,7	2,9	70,0
72,0	2,6	2,6	-	2,4	2,4	-	72,0
74,0	2,4	2,4	-	2,0	2,0	-	74,0
76,0	2,3	2,3	-	1,7	1,7	-	76,0
78,0	2,1	2,1	-	1,4	1,4	-	78,0
80,0	1,5	-	-	1,1	1,1	-	80,0

*Luffing under load • Unter Teillast wippbar • Inclinaison sous charge • Angulación con carga • Brandeggio sotto carico • Изменение вылета под нагрузкой

Load charts • Traglasten • Capacités de levage Capacidades • Capacità • Таблицы грузоподъемности

Swingaway (hydraulic luffing) • Klappspitze (hydraulisch wippbar) • Extension treillis (déport hydraulique)
Plumín (angulable hidráulicamente) • Falcone (brandeggio idraulico) • Складной удлинитель стрелы
(гидравлическое изменение вылета)



74,8 - 80,0 m



21,0 m



8,5 m



360°



92,5 t



EN 13000

m	74,8			80,0			m
	5°	* 5° - 20°	* 20° - 40°	5°	* 5° - 20°	* 20° - 40°	
20,0	5,0	-	-	4,3	-	-	20,0
22,0	5,0	-	-	4,3	-	-	22,0
24,0	5,0	5,0	-	4,3	-	-	24,0
26,0	5,0	5,0	-	4,3	4,3	-	26,0
28,0	5,0	5,0	-	4,3	4,3	-	28,0
30,0	5,0	4,9	4,1	4,3	4,3	-	30,0
32,0	5,0	4,8	4,1	4,3	4,3	4,0	32,0
34,0	5,0	4,7	4,0	4,3	4,3	4,0	34,0
36,0	5,0	4,6	4,0	4,3	4,3	3,9	36,0
38,0	5,0	4,6	3,9	4,3	4,3	3,9	38,0
40,0	5,0	4,5	3,9	4,3	4,3	3,9	40,0
42,0	5,0	4,4	3,9	4,3	4,3	3,8	42,0
44,0	5,0	4,3	3,8	4,3	4,3	3,8	44,0
46,0	4,9	4,3	3,8	4,3	4,2	3,8	46,0
48,0	4,8	4,2	3,8	4,3	4,1	3,7	48,0
50,0	4,7	4,1	3,7	4,3	4,1	3,7	50,0
52,0	4,6	4,1	3,7	4,3	4,0	3,7	52,0
54,0	4,5	4,0	3,7	4,3	4,0	3,7	54,0
56,0	4,4	4,0	3,7	4,3	3,9	3,7	56,0
58,0	4,3	3,9	3,7	4,3	3,9	3,7	58,0
60,0	4,3	3,9	3,7	4,2	3,9	3,6	60,0
62,0	4,1	3,8	3,7	4,0	3,8	3,6	62,0
64,0	3,9	3,8	3,7	3,8	3,8	3,6	64,0
66,0	3,6	3,6	3,7	3,7	3,7	3,6	66,0
68,0	3,3	3,3	3,6	3,4	3,4	3,5	68,0
70,0	3,0	3,0	3,3	3,2	3,2	3,4	70,0
72,0	2,7	2,7	3,0	2,9	2,9	3,2	72,0
74,0	2,5	2,5	2,7	2,7	2,7	3,0	74,0
76,0	2,4	2,4	-	2,4	2,4	2,7	76,0
78,0	2,2	2,2	-	2,0	2,0	2,3	78,0
80,0	2,0	2,0	-	1,7	1,7	-	80,0
82,0	1,9	1,9	-	1,5	1,5	-	82,0
84,0	1,7	1,7	-	1,2	1,2	-	84,0
86,0	1,6	1,6	-	0,9	0,9	-	86,0
88,0	1,3	1,3	-	-	-	-	88,0

*Luffing under load • Unter Teillast wippbar • Inclinaison sous charge • Angulación con carga • Brandeggio sotto carico • Изменение вылета под нагрузкой

Load charts • Traglasten • Capacités de levage Capacidades • Capacità • Таблицы грузоподъемности

Swingaway (hydraulic luffing) • Klappspitze (hydraulisch wippbar) • Extension treillis (déport hydraulique)
Plumín (angulable hidráulicamente) • Falcone (brandeggio idraulico) • Складной удлинитель стрелы
(гидравлическое изменение вылета)



74,8 - 80,0 m



29,0 m



8,5 m



360°



92,5 t



EN 13000

m	74,8 29,0			80,0 29,0			m
	5°	* 5° - 20°	* 20° - 40°	5°	* 5° - 20°	* 20° - 40°	
22,0	3,8	-	-	3,3	-	-	22,0
24,0	3,8	-	-	3,3	-	-	24,0
26,0	3,8	-	-	3,3	-	-	26,0
28,0	3,8	3,7	-	3,3	3,3	-	28,0
30,0	3,8	3,6	-	3,3	3,3	-	30,0
32,0	3,8	3,6	3,1	3,3	3,3	-	32,0
34,0	3,8	3,5	3,1	3,3	3,3	2,8	34,0
36,0	3,7	3,5	3,1	3,3	3,2	2,8	36,0
38,0	3,7	3,4	3,1	3,3	3,2	2,8	38,0
40,0	3,6	3,4	3,1	3,3	3,1	2,8	40,0
42,0	3,6	3,3	3,1	3,3	3,1	2,8	42,0
44,0	3,5	3,3	3,1	3,2	3,1	2,8	44,0
46,0	3,4	3,2	3,1	3,2	3,0	2,8	46,0
48,0	3,4	3,2	3,1	3,2	3,0	2,8	48,0
50,0	3,3	3,1	3,0	3,1	3,0	2,8	50,0
52,0	3,3	3,1	3,0	3,1	2,9	2,8	52,0
54,0	3,2	3,1	2,9	3,0	2,9	2,8	54,0
56,0	3,2	3,0	2,9	3,0	2,9	2,8	56,0
58,0	3,1	2,9	2,9	3,0	2,8	2,8	58,0
60,0	3,1	2,9	2,8	2,9	2,8	2,8	60,0
62,0	3,0	2,8	2,8	2,9	2,8	2,8	62,0
64,0	2,9	2,8	2,7	2,9	2,8	2,7	64,0
66,0	2,9	2,7	2,7	2,8	2,7	2,7	66,0
68,0	2,8	2,7	2,7	2,8	2,7	2,7	68,0
70,0	2,8	2,7	2,7	2,8	2,6	2,6	70,0
72,0	2,7	2,6	2,6	2,7	2,6	2,6	72,0
74,0	2,5	2,5	2,6	2,6	2,6	2,6	74,0
76,0	2,3	2,4	2,5	2,5	2,5	2,6	76,0
78,0	2,1	2,3	2,5	2,2	2,2	2,5	78,0
80,0	1,9	2,1	-	1,9	1,9	2,2	80,0
82,0	1,8	1,9	-	1,6	1,6	1,9	82,0
84,0	1,6	1,7	-	1,3	1,3	-	84,0
86,0	1,5	1,6	-	1,1	1,1	-	86,0
88,0	1,3	1,4	-	-	-	-	88,0
90,0	1,2	1,3	-	-	-	-	90,0
92,0	1,0	1,0	-	-	-	-	92,0

*Luffing under load • Unter Teillast wippbar • Inclinaison sous charge • Angulación con carga • Brandeggio sotto carico • Изменение вылета под нагрузкой

Load charts • Traglasten • Capacités de levage Capacidades • Capacità • Таблицы грузоподъемности

Swingaway (hydraulic luffing) • Klappspitze (hydraulisch wippbar) • Extension treillis (déport hydraulique)
Plumín (angulable hidráulicamente) • Falcone (brandeggio idraulico) • Складной удлинитель стрелы
(гидравлическое изменение вылета)



74,8 - 80,0 m



37,0 m



8,5 m



360°



92,5 t



EN 13000

m	74,8 37,0			80,0 37,0			m
	5°	* 5° - 20°	* 20° - 40°	5°	* 5° - 20°	* 20° - 40°	
24,0	2,5	-	-	-	-	-	24,0
26,0	2,5	-	-	2,1	-	-	26,0
28,0	2,5	-	-	2,1	-	-	28,0
30,0	2,5	2,5	-	2,1	2,1	-	30,0
32,0	2,5	2,5	1,9	2,1	2,1	-	32,0
34,0	2,5	2,5	1,9	2,1	2,1	-	34,0
36,0	2,5	2,4	1,9	2,1	2,1	1,6	36,0
38,0	2,5	2,4	1,9	2,1	2,1	1,6	38,0
40,0	2,5	2,3	1,9	2,1	2,1	1,6	40,0
42,0	2,4	2,3	1,9	2,1	2,1	1,6	42,0
44,0	2,4	2,3	1,9	2,1	2,1	1,6	44,0
46,0	2,3	2,2	1,9	2,1	2,0	1,6	46,0
48,0	2,3	2,2	1,9	2,1	2,0	1,6	48,0
50,0	2,2	2,1	1,9	2,1	2,0	1,6	50,0
52,0	2,2	2,1	1,9	2,0	1,9	1,6	52,0
54,0	2,1	2,1	1,9	2,0	1,9	1,6	54,0
56,0	2,1	2,0	1,9	2,0	1,9	1,6	56,0
58,0	2,1	2,0	1,9	1,9	1,9	1,6	58,0
60,0	2,0	2,0	1,9	1,9	1,8	1,6	60,0
62,0	2,0	1,9	1,9	1,9	1,8	1,6	62,0
64,0	1,9	1,9	1,9	1,8	1,8	1,6	64,0
66,0	1,9	1,9	1,9	1,8	1,8	1,6	66,0
68,0	1,9	1,8	1,9	1,8	1,7	1,6	68,0
70,0	1,8	1,8	1,9	1,8	1,7	1,6	70,0
72,0	1,8	1,8	1,8	1,7	1,7	1,6	72,0
74,0	1,8	1,7	1,8	1,7	1,7	1,6	74,0
76,0	1,7	1,7	1,8	1,7	1,6	1,6	76,0
78,0	1,7	1,7	1,7	1,6	1,6	1,6	78,0
80,0	1,7	1,7	1,7	1,6	1,6	1,6	80,0
82,0	1,6	1,6	1,7	1,6	1,6	1,6	82,0
84,0	1,5	1,6	1,6	1,4	1,4	1,6	84,0
86,0	1,4	1,5	-	1,2	1,2	1,4	86,0
88,0	1,2	1,4	-	0,9	0,9	-	88,0
90,0	1,1	1,2	-	-	-	-	90,0
92,0	0,9	1,1	-	-	-	-	92,0
94,0	-	0,9	-	-	-	-	94,0

*Luffing under load • Unter Teillast wippbar • Inclinaison sous charge • Angulación con carga • Brandeggio sotto carico • Изменение вылета под нагрузкой

Load charts • Traglasten • Capacités de levage Capacidades • Capacità • Таблицы грузоподъемности

Swingaway (hydraulic luffing) • Klappspitze (hydraulisch wippbar) • Extension treillis (déport hydraulique)
Plumín (angulable hidráulicamente) • Falcone (brandeggio idraulico) • Складной удлинитель стрелы
(гидравлическое изменение вылета)



74,8 - 80,0 m



12,0 m



8,5 m



360°



74,5 t



EN 13000

m	74,8 12,0			80,0 12,0			m
	5°	* 5° - 20°	* 20° - 40°	5°	* 5° - 20°	* 20° - 40°	
16,0	8,4	-	-	-	-	-	16,0
18,0	8,4	-	-	6,8	-	-	18,0
20,0	8,4	8,2	-	6,8	-	-	20,0
22,0	8,4	8,2	7,8	6,8	6,7	6,7	22,0
24,0	8,4	8,2	7,7	6,8	6,7	6,7	24,0
26,0	8,4	8,2	7,6	6,8	6,7	6,7	26,0
28,0	8,4	8,2	7,6	6,8	6,7	6,7	28,0
30,0	8,4	8,2	7,5	6,8	6,7	6,7	30,0
32,0	8,4	8,2	7,4	6,8	6,7	6,7	32,0
34,0	8,4	8,2	7,3	6,8	6,7	6,7	34,0
36,0	8,4	8,1	7,3	6,8	6,7	6,7	36,0
38,0	8,4	8,0	7,2	6,8	6,7	6,7	38,0
40,0	8,2	7,9	7,2	6,8	6,7	6,7	40,0
42,0	7,8	7,7	7,1	6,8	6,7	6,6	42,0
44,0	7,3	7,3	7,1	6,8	6,6	6,4	44,0
46,0	6,8	6,8	7,0	6,5	6,4	6,3	46,0
48,0	6,1	6,1	6,4	6,2	6,2	6,2	48,0
50,0	5,6	5,6	5,8	5,7	5,7	6,0	50,0
52,0	5,3	5,3	5,4	5,1	5,1	5,4	52,0
54,0	4,9	4,9	5,1	4,5	4,5	4,8	54,0
56,0	4,6	4,6	4,8	3,9	3,9	4,2	56,0
58,0	4,1	4,1	4,4	3,4	3,4	3,7	58,0
60,0	3,7	3,7	3,9	3,0	3,0	3,2	60,0
62,0	3,2	3,2	3,4	2,5	2,5	2,8	62,0
64,0	2,8	2,8	3,0	2,1	2,1	2,3	64,0
66,0	2,4	2,4	2,6	1,7	1,7	1,9	66,0
68,0	2,1	2,1	-	1,4	1,4	1,5	68,0
70,0	1,7	1,7	-	1,0	1,0	1,2	70,0
72,0	1,4	1,4	-	-	-	-	72,0
74,0	1,1	1,1	-	-	-	-	74,0

*Luffing under load • Unter Teillast wippbar • Inclinaison sous charge • Angulación con carga • Brandeggio sotto carico • Изменение вылета под нагрузкой

Load charts • Traglasten • Capacités de levage Capacidades • Capacità • Таблицы грузоподъемности

Swingaway (hydraulic luffing) • Klappspitze (hydraulisch wippbar) • Extension treillis (déport hydraulique)
Plumín (angulable hidráulicamente) • Falcone (brandeggio idraulico) • Складной удлинитель стрелы
(гидравлическое изменение вылета)



74,8 - 80,0 m



21,0 m



8,5 m



360°



74,5 t



EN 13000

m	74,8			80,0			m
	5°	* 5° - 20°	* 20° - 40°	5°	* 5° - 20°	* 20° - 40°	
20,0	5,0	-	-	4,3	-	-	20,0
22,0	5,0	-	-	4,3	-	-	22,0
24,0	5,0	5,0	-	4,3	-	-	24,0
26,0	5,0	5,0	-	4,3	4,3	-	26,0
28,0	5,0	5,0	-	4,3	4,3	-	28,0
30,0	5,0	4,9	4,1	4,3	4,3	-	30,0
32,0	5,0	4,8	4,1	4,3	4,3	4,0	32,0
34,0	5,0	4,7	4,0	4,3	4,3	4,0	34,0
36,0	5,0	4,6	4,0	4,3	4,3	3,9	36,0
38,0	5,0	4,6	3,9	4,3	4,3	3,9	38,0
40,0	5,0	4,5	3,9	4,3	4,3	3,9	40,0
42,0	5,0	4,4	3,9	4,3	4,3	3,8	42,0
44,0	5,0	4,3	3,8	4,3	4,3	3,8	44,0
46,0	4,9	4,3	3,8	4,3	4,2	3,8	46,0
48,0	4,8	4,2	3,8	4,3	4,1	3,7	48,0
50,0	4,7	4,1	3,7	4,3	4,1	3,7	50,0
52,0	4,6	4,1	3,7	4,3	4,0	3,7	52,0
54,0	4,5	4,0	3,7	4,3	4,0	3,7	54,0
56,0	4,4	4,0	3,7	4,3	3,9	3,7	56,0
58,0	4,2	3,9	3,7	4,2	3,9	3,7	58,0
60,0	4,1	3,8	3,7	3,7	3,7	3,6	60,0
62,0	3,8	3,8	3,7	3,3	3,3	3,6	62,0
64,0	3,5	3,5	3,6	2,9	2,9	3,3	64,0
66,0	3,1	3,1	3,5	2,5	2,5	2,9	66,0
68,0	2,8	2,8	3,1	2,1	2,1	2,5	68,0
70,0	2,4	2,4	2,7	1,7	1,7	2,1	70,0
72,0	2,1	2,1	2,4	1,4	1,4	1,8	72,0
74,0	1,8	1,8	2,0	1,1	1,1	1,4	74,0
76,0	1,5	1,5	-	-	-	1,1	76,0
78,0	1,2	1,2	-	-	-	-	78,0
80,0	1,0	1,0	-	-	-	-	80,0

*Luffing under load • Unter Teillast wippbar • Inclinaison sous charge • Angulación con carga • Brandeggio sotto carico • Изменение вылета под нагрузкой

Load charts • Traglasten • Capacités de levage Capacidades • Capacità • Таблицы грузоподъемности

Swingaway (hydraulic luffing) • Klappspitze (hydraulisch wippbar) • Extension treillis (déport hydraulique)
Plumín (angulable hidráulicamente) • Falcone (brandeggio idraulico) • Складной удлинитель стрелы
(гидравлическое изменение вылета)



74,8 - 80,0 m



29,0 m



8,5 m



360°



74,5 t



EN 13000

m	74,8 29,0			80,0 29,0			m
	5°	* 5° - 20°	* 20° - 40°	5°	* 5° - 20°	* 20° - 40°	
22,0	3,8	-	-	3,3	-	-	22,0
24,0	3,8	-	-	3,3	-	-	24,0
26,0	3,8	-	-	3,3	-	-	26,0
28,0	3,8	3,7	-	3,3	3,3	-	28,0
30,0	3,8	3,6	-	3,3	3,3	-	30,0
32,0	3,8	3,6	-	3,3	3,3	-	32,0
34,0	3,8	3,5	3,1	3,3	3,3	2,8	34,0
36,0	3,7	3,5	3,1	3,3	3,2	2,8	36,0
38,0	3,7	3,4	3,1	3,3	3,2	2,8	38,0
40,0	3,6	3,4	3,1	3,3	3,1	2,8	40,0
42,0	3,6	3,3	3,1	3,3	3,1	2,8	42,0
44,0	3,5	3,3	3,1	3,2	3,1	2,8	44,0
46,0	3,4	3,2	3,1	3,2	3,0	2,8	46,0
48,0	3,4	3,2	3,1	3,2	3,0	2,8	48,0
50,0	3,3	3,1	3,0	3,1	3,0	2,8	50,0
52,0	3,3	3,1	3,0	3,1	2,9	2,8	52,0
54,0	3,2	3,1	2,9	3,0	2,9	2,8	54,0
56,0	3,2	3,0	2,9	3,0	2,9	2,8	56,0
58,0	3,1	2,9	2,9	3,0	2,8	2,8	58,0
60,0	3,1	2,9	2,8	2,9	2,8	2,8	60,0
62,0	3,0	2,8	2,8	2,9	2,8	2,8	62,0
64,0	2,9	2,8	2,7	2,9	2,8	2,7	64,0
66,0	2,8	2,7	2,7	2,6	2,6	2,7	66,0
68,0	2,8	2,7	2,7	2,2	2,2	2,7	68,0
70,0	2,6	2,6	2,6	1,9	1,9	2,3	70,0
72,0	2,2	2,2	2,6	1,6	1,6	1,9	72,0
74,0	1,9	1,9	2,2	1,3	1,3	1,6	74,0
76,0	1,6	1,6	1,9	1,0	1,0	1,3	76,0
78,0	1,3	1,3	1,6	-	-	1,0	78,0
80,0	1,1	1,1	-	-	-	-	80,0

*Luffing under load • Unter Teillast wippbar • Inclinaison sous charge • Angulación con carga • Brandeggio sotto carico • Изменение вылета под нагрузкой

Load charts • Traglasten • Capacités de levage Capacidades • Capacità • Таблицы грузоподъемности

Swingaway (hydraulic luffing) • Klappspitze (hydraulisch wippbar) • Extension treillis (déport hydraulique)
Plumín (angulable hidráulicamente) • Falcone (brandeggio idraulico) • Складной удлинитель стрелы
(гидравлическое изменение вылета)



74,8 - 80,0 m



37,0 m



8,5 m



360°



74,5 t



EN 13000

m	74,8			80,0			m
	5°	* 5° - 20°	* 20° - 40°	5°	* 5° - 20°	* 20° - 40°	
24,0	2,5	-	-	-	-	-	24,0
26,0	2,5	-	-	2,1	-	-	26,0
28,0	2,5	-	-	2,1	-	-	28,0
30,0	2,5	2,5	-	2,1	2,1	-	30,0
32,0	2,5	2,5	-	2,1	2,1	-	32,0
34,0	2,5	2,5	1,9	2,1	2,1	-	34,0
36,0	2,5	2,4	1,9	2,1	2,1	1,6	36,0
38,0	2,5	2,4	1,9	2,1	2,1	1,6	38,0
40,0	2,5	2,3	1,9	2,1	2,1	1,6	40,0
42,0	2,4	2,3	1,9	2,1	2,1	1,6	42,0
44,0	2,4	2,3	1,9	2,1	2,1	1,6	44,0
46,0	2,3	2,2	1,9	2,1	2,0	1,6	46,0
48,0	2,3	2,2	1,9	2,1	2,0	1,6	48,0
50,0	2,2	2,1	1,9	2,1	2,0	1,6	50,0
52,0	2,2	2,1	1,9	2,0	1,9	1,6	52,0
54,0	2,1	2,1	1,9	2,0	1,9	1,6	54,0
56,0	2,1	2,0	1,9	2,0	1,9	1,6	56,0
58,0	2,1	2,0	1,9	1,9	1,9	1,6	58,0
60,0	2,0	2,0	1,9	1,9	1,8	1,6	60,0
62,0	2,0	1,9	1,9	1,9	1,8	1,6	62,0
64,0	1,9	1,9	1,9	1,8	1,8	1,6	64,0
66,0	1,9	1,9	1,9	1,8	1,8	1,6	66,0
68,0	1,9	1,8	1,9	1,8	1,7	1,6	68,0
70,0	1,8	1,8	1,9	1,8	1,7	1,6	70,0
72,0	1,8	1,7	1,8	1,6	1,6	1,6	72,0
74,0	1,7	1,7	1,7	1,3	1,3	1,6	74,0
76,0	1,7	1,7	1,7	1,0	1,0	1,4	76,0
78,0	1,4	1,4	1,7	-	-	1,1	78,0
80,0	1,2	1,2	1,4	-	-	-	80,0
82,0	0,9	0,9	1,2	-	-	-	82,0
84,0	-	-	0,9	-	-	-	84,0

*Luffing under load • Unter Teillast wippbar • Inclinaison sous charge • Angulación con carga • Brandeggio sotto carico • Изменение вылета под нагрузкой

Load charts • Traglasten • Capacités de levage Capacidades • Capacità • Таблицы грузоподъемности

Swingaway (hydraulic luffing) • Klappspitze (hydraulisch wippbar) • Extension treillis (déport hydraulique)
Plumín (angulable hidráulicamente) • Falcone (brandeggio idraulico) • Складной удлинитель стрелы
(гидравлическое изменение вылета)



74,8 - 80,0 m



12,0 m



8,5 m



360°



54,5 t



EN 13000

m	74,8 12,0			80,0 12,0			m
	5°	* 5° - 20°	* 20° - 40°	5°	* 5° - 20°	* 20° - 40°	
16,0	8,4	-	-	-	-	-	16,0
18,0	8,4	-	-	6,8	-	-	18,0
20,0	8,4	8,2	-	6,8	-	-	20,0
22,0	8,4	8,2	7,8	6,8	6,7	6,7	22,0
24,0	8,4	8,2	7,7	6,8	6,7	6,7	24,0
26,0	8,4	8,2	7,6	6,8	6,7	6,7	26,0
28,0	8,4	8,2	7,6	6,8	6,7	6,7	28,0
30,0	8,4	8,2	7,5	6,8	6,7	6,7	30,0
32,0	8,4	8,2	7,4	6,8	6,7	6,7	32,0
34,0	8,4	8,2	7,3	6,8	6,7	6,7	34,0
36,0	7,9	7,7	7,3	6,8	6,7	6,7	36,0
38,0	7,6	7,2	7,2	6,8	6,7	6,7	38,0
40,0	7,2	7,0	6,7	6,2	6,2	6,7	40,0
42,0	6,4	6,4	6,5	5,4	5,4	5,9	42,0
44,0	5,7	5,7	6,1	4,7	4,7	5,1	44,0
46,0	5,0	5,0	5,4	4,0	4,0	4,4	46,0
48,0	4,4	4,4	4,7	3,4	3,4	3,8	48,0
50,0	3,8	3,8	4,1	2,9	2,9	3,2	50,0
52,0	3,2	3,2	3,5	2,4	2,4	2,7	52,0
54,0	2,7	2,7	3,0	1,9	1,9	2,2	54,0
56,0	2,2	2,2	2,5	1,4	1,4	1,7	56,0
58,0	1,7	1,7	2,0	0,9	0,9	1,2	58,0
60,0	1,3	1,3	1,5	-	-	-	60,0
62,0	-	0,9	1,1	-	-	-	62,0

*Luffing under load • Unter Teillast wippbar • Inclinaison sous charge • Angulación con carga • Brandeggio sotto carico • Изменение вылета под нагрузкой

Load charts • Traglasten • Capacités de levage Capacidades • Capacità • Таблицы грузоподъемности

Swingaway (hydraulic luffing) • Klappspitze (hydraulisch wippbar) • Extension treillis (déport hydraulique)
Plumín (angulable hidráulicamente) • Falcone (brandeggio idraulico) • Складной удлинитель стрелы
(гидравлическое изменение вылета)



74,8 - 80,0 m



21,0 m



8,5 m



360°



54,5 t



EN 13000

m	74,8			80,0			m
	5°	* 5° - 20°	* 20° - 40°	5°	* 5° - 20°	* 20° - 40°	
20,0	5,0	-	-	4,3	-	-	20,0
22,0	5,0	-	-	4,3	-	-	22,0
24,0	5,0	5,0	-	4,3	-	-	24,0
26,0	5,0	5,0	-	4,3	4,3	-	26,0
28,0	5,0	5,0	-	4,3	4,3	-	28,0
30,0	5,0	4,9	4,1	4,3	4,3	-	30,0
32,0	5,0	4,8	4,1	4,3	4,3	4,0	32,0
34,0	5,0	4,7	4,0	4,3	4,3	4,0	34,0
36,0	5,0	4,6	4,0	4,3	4,3	3,9	36,0
38,0	5,0	4,6	3,9	4,3	4,3	3,9	38,0
40,0	5,0	4,5	3,9	4,3	4,3	3,9	40,0
42,0	5,0	4,4	3,9	4,3	4,3	3,8	42,0
44,0	5,0	4,3	3,8	4,3	4,3	3,8	44,0
46,0	4,8	4,3	3,8	4,3	4,2	3,8	46,0
48,0	4,7	4,1	3,8	4,2	4,1	3,7	48,0
50,0	4,5	4,1	3,7	3,6	3,6	3,7	50,0
52,0	4,0	4,0	3,7	3,1	3,1	3,7	52,0
54,0	3,5	3,5	3,7	2,6	2,6	3,3	54,0
56,0	3,0	3,0	3,6	2,2	2,2	2,8	56,0
58,0	2,6	2,6	3,1	1,8	1,8	2,3	58,0
60,0	2,2	2,2	2,7	1,4	1,4	1,9	60,0
62,0	1,7	1,7	2,2	0,9	0,9	1,5	62,0
64,0	1,3	1,3	1,8	-	-	1,1	64,0
66,0	1,0	1,0	1,4	-	-	-	66,0
68,0	-	-	1,0	-	-	-	68,0

*Luffing under load • Unter Teillast wippbar • Inclinaison sous charge • Angulación con carga • Brandeggio sotto carico • Изменение вылета под нагрузкой

Load charts • Traglasten • Capacités de levage Capacidades • Capacità • Таблицы грузоподъемности

Swingaway (hydraulic luffing) • Klappspitze (hydraulisch wippbar) • Extension treillis (déport hydraulique)
Plumín (angulable hidráulicamente) • Falcone (brandeggio idraulico) • Складной удлинитель стрелы
(гидравлическое изменение вылета)



74,8 - 80,0 m



29,0 m



8,5 m



360°



54,5 t



EN 13000

m	74,8 29,0			80,0 29,0			m
	5°	* 5° - 20°	* 20° - 40°	5°	* 5° - 20°	* 20° - 40°	
22,0	3,8	-	-	3,3	-	-	22,0
24,0	3,8	-	-	3,3	-	-	24,0
26,0	3,8	-	-	3,3	-	-	26,0
28,0	3,8	3,7	-	3,3	3,3	-	28,0
30,0	3,8	3,6	-	3,3	3,3	-	30,0
32,0	3,8	3,6	-	3,3	3,3	-	32,0
34,0	3,8	3,5	3,1	3,3	3,3	-	34,0
36,0	3,7	3,5	3,1	3,3	3,2	2,8	36,0
38,0	3,7	3,4	3,1	3,3	3,2	2,8	38,0
40,0	3,6	3,4	3,1	3,3	3,1	2,8	40,0
42,0	3,6	3,3	3,1	3,3	3,1	2,8	42,0
44,0	3,5	3,3	3,1	3,2	3,1	2,8	44,0
46,0	3,4	3,2	3,1	3,2	3,0	2,8	46,0
48,0	3,4	3,2	3,1	3,2	3,0	2,8	48,0
50,0	3,3	3,1	3,0	3,1	3,0	2,8	50,0
52,0	3,2	3,1	3,0	3,1	2,9	2,8	52,0
54,0	3,1	3,0	2,9	2,7	2,7	2,8	54,0
56,0	3,1	2,9	2,9	2,2	2,2	2,8	56,0
58,0	2,7	2,7	2,8	1,8	1,8	2,4	58,0
60,0	2,3	2,3	2,8	1,4	1,4	2,0	60,0
62,0	1,9	1,9	2,4	1,1	1,1	1,6	62,0
64,0	1,5	1,5	2,0	-	-	1,2	64,0
66,0	1,1	1,1	1,6	-	-	0,9	66,0
68,0	-	-	1,2	-	-	-	68,0
70,0	-	-	0,9	-	-	-	70,0

*Luffing under load • Unter Teillast wippbar • Inclinaison sous charge • Angulación con carga • Brandeggio sotto carico • Изменение вылета под нагрузкой

Load charts • Traglasten • Capacités de levage Capacidades • Capacità • Таблицы грузоподъемности

Swingaway (hydraulic luffing) • Klappspitze (hydraulisch wippbar) • Extension treillis (déport hydraulique)
Plumín (angulable hidráulicamente) • Falcone (brandeggio idraulico) • Складной удлинитель стрелы
(гидравлическое изменение вылета)



74,8 - 80,0 m



37,0 m



8,5 m



360°



54,5 t



EN 13000

m	74,8 37,0			80,0 37,0			m
	5°	* 5° - 20°	* 20° - 40°	5°	* 5° - 20°	* 20° - 40°	
24,0	2,5	-	-	-	-	-	24,0
26,0	2,5	-	-	2,1	-	-	26,0
28,0	2,5	-	-	2,1	-	-	28,0
30,0	2,5	2,5	-	2,1	2,1	-	30,0
32,0	2,5	2,5	-	2,1	2,1	-	32,0
34,0	2,5	2,5	1,9	2,1	2,1	-	34,0
36,0	2,5	2,4	1,9	2,1	2,1	1,6	36,0
38,0	2,5	2,4	1,9	2,1	2,1	1,6	38,0
40,0	2,5	2,3	1,9	2,1	2,1	1,6	40,0
42,0	2,4	2,3	1,9	2,1	2,1	1,6	42,0
44,0	2,4	2,3	1,9	2,1	2,1	1,6	44,0
46,0	2,3	2,2	1,9	2,1	2,0	1,6	46,0
48,0	2,3	2,2	1,9	2,1	2,0	1,6	48,0
50,0	2,2	2,1	1,9	2,1	2,0	1,6	50,0
52,0	2,2	2,1	1,9	2,0	1,9	1,6	52,0
54,0	2,1	2,1	1,9	2,0	1,9	1,6	54,0
56,0	2,1	2,0	1,9	2,0	1,9	1,6	56,0
58,0	2,0	1,9	1,9	1,8	1,8	1,6	58,0
60,0	2,0	1,9	1,8	1,4	1,4	1,6	60,0
62,0	1,9	1,9	1,7	1,1	1,1	1,6	62,0
64,0	1,6	1,6	1,7	-	-	1,2	64,0
66,0	1,2	1,2	1,7	-	-	0,9	66,0
68,0	0,9	0,9	1,3	-	-	-	68,0
70,0	-	-	1,0	-	-	-	70,0

*Luffing under load • Unter Teillast wippbar • Inclinaison sous charge • Angulación con carga • Brandeggio sotto carico • Изменение вылета под нагрузкой

Load charts • Traglasten • Capacités de levage Capacidades • Capacità • Таблицы грузоподъемности

Swingaway (hydraulic luffing) • Klappspitze (hydraulisch wippbar) • Extension treillis (déport hydraulique)
Plumín (angulable hidráulicamente) • Falcone (brandeggio idraulico) • Складной удлинитель стрелы
(гидравлическое изменение вылета)



74,8 - 80,0 m



12,0 m



8,5 m



360°



45,0 t



EN 13000

m	74,8 12,0			80,0 12,0			m
	5°	* 5° - 20°	* 20° - 40°	5°	* 5° - 20°	* 20° - 40°	
16,0	8,4	-	-	-	-	-	16,0
18,0	8,4	-	-	6,8	-	-	18,0
20,0	8,4	8,2	-	6,8	-	-	20,0
22,0	8,4	8,2	7,8	6,8	6,7	6,7	22,0
24,0	8,4	8,2	7,7	6,8	6,7	6,7	24,0
26,0	8,4	8,2	7,6	6,8	6,7	6,7	26,0
28,0	8,4	8,2	7,6	6,8	6,7	6,7	28,0
30,0	8,4	8,2	7,5	6,8	6,7	6,7	30,0
32,0	7,9	7,9	7,4	6,8	6,7	6,7	32,0
34,0	7,9	7,7	7,3	6,8	6,7	6,7	34,0
36,0	7,1	7,1	7,0	6,1	6,1	6,7	36,0
38,0	6,3	6,3	6,8	5,2	5,2	5,8	38,0
40,0	5,5	5,5	5,9	4,5	4,5	5,0	40,0
42,0	4,8	4,8	5,2	3,7	3,7	4,2	42,0
44,0	4,1	4,1	4,5	3,1	3,1	3,5	44,0
46,0	3,5	3,5	3,9	2,5	2,5	2,9	46,0
48,0	2,9	2,9	3,3	1,9	1,9	2,3	48,0
50,0	2,3	2,3	2,7	1,4	1,4	1,8	50,0
52,0	1,8	1,8	2,1	1,0	1,0	1,3	52,0
54,0	1,3	1,3	1,6	-	-	-	54,0
56,0	-	-	1,1	-	-	-	56,0

*Luffing under load • Unter Teillast wippbar • Inclinaison sous charge • Angulación con carga • Brandeggio sotto carico • Изменение вылета под нагрузкой



74,8 - 80,0 m



21,0 m



8,5 m



360°



45,0 t



EN 13000

m	74,8 21,0			80,0 21,0			m
	5°	* 5° - 20°	* 20° - 40°	5°	* 5° - 20°	* 20° - 40°	
20,0	5,0	-	-	-	-	-	20,0
22,0	5,0	-	-	4,3	-	-	22,0
24,0	5,0	5,0	-	4,3	-	-	24,0
26,0	5,0	5,0	-	4,3	4,3	-	26,0
28,0	5,0	5,0	-	4,3	4,3	-	28,0
30,0	5,0	4,9	4,1	4,3	4,3	-	30,0
32,0	5,0	4,8	4,1	4,3	4,3	4,0	32,0
34,0	5,0	4,7	4,0	4,3	4,3	4,0	34,0
36,0	5,0	4,6	4,0	4,3	4,3	3,9	36,0
38,0	5,0	4,6	3,9	4,3	4,3	3,9	38,0
40,0	5,0	4,5	3,9	4,3	4,3	3,9	40,0
42,0	4,8	4,3	3,9	4,3	4,3	3,8	42,0
44,0	4,8	4,3	3,8	3,9	3,9	3,8	44,0
46,0	4,2	4,2	3,8	2,7	3,3	3,8	46,0
48,0	3,6	3,6	3,7	2,2	2,7	3,5	48,0
50,0	3,1	3,1	3,7	1,7	2,2	2,9	50,0
52,0	2,7	2,7	3,3	1,3	1,7	2,4	52,0
54,0	2,2	2,2	2,8	0,9	1,3	1,9	54,0
56,0	1,7	1,7	2,3	-	0,9	1,5	56,0
58,0	1,3	1,3	1,9	-	-	1,1	58,0
60,0	0,9	0,9	1,4	-	-	-	60,0
62,0	-	-	1,0	-	-	-	62,0

*Luffing under load • Unter Teillast wippbar • Inclinaison sous charge • Angulación con carga • Brandeggio sotto carico • Изменение вылета под нагрузкой

Load charts • Traglasten • Capacités de levage Capacidades • Capacità • Таблицы грузоподъемности

Swingaway (hydraulic luffing) • Klappspitze (hydraulisch wippbar) • Extension treillis (déport hydraulique)
Plumín (angulable hidráulicamente) • Falcone (brandeggio idraulico) • Складной удлинитель стрелы
(гидравлическое изменение вылета)



74,8 - 80,0 m



29,0 m



8,5 m



360°



45,0 t



EN 13000

m	74,8 29,0			80,0 29,0			m
	5°	* 5° - 20°	* 20° - 40°	5°	* 5° - 20°	* 20° - 40°	
22,0	3,8	-	-	3,3	-	-	22,0
24,0	3,8	-	-	3,3	-	-	24,0
26,0	3,8	-	-	3,3	-	-	26,0
28,0	3,8	3,7	-	3,3	3,3	-	28,0
30,0	3,8	3,6	-	3,3	3,3	-	30,0
32,0	3,8	3,6	3,1	3,3	3,3	-	32,0
34,0	3,8	3,5	3,1	3,3	3,3	2,8	34,0
36,0	3,7	3,5	3,1	3,3	3,2	2,8	36,0
38,0	3,7	3,4	3,1	3,3	3,2	2,8	38,0
40,0	3,6	3,4	3,1	3,3	3,1	2,8	40,0
42,0	3,6	3,3	3,1	3,3	3,1	2,8	42,0
44,0	3,5	3,3	3,1	3,2	3,1	2,8	44,0
46,0	3,3	3,2	3,1	3,2	3,0	2,8	46,0
48,0	3,3	3,1	3,1	2,8	2,8	2,8	48,0
50,0	3,2	3,1	3,0	2,3	2,3	2,8	50,0
52,0	2,7	2,7	3,0	1,8	1,8	2,5	52,0
54,0	2,2	2,2	2,8	1,4	1,4	2,0	54,0
56,0	1,8	1,8	2,4	1,0	1,0	1,6	56,0
58,0	1,5	1,5	2,0	-	-	1,2	58,0
60,0	1,1	1,1	1,6	-	-	-	60,0
62,0	-	-	1,2	-	-	-	62,0

*Luffing under load • Unter Teillast wippbar • Inclinaison sous charge • Angulación con carga • Brandeggio sotto carico • Изменение вылета под нагрузкой



74,8 - 80,0 m



37,0 m



8,5 m



360°



45,0 t



EN 13000

m	74,8 37,0			80,0 37,0			m
	5°	* 5° - 20°	* 20° - 40°	5°	* 5° - 20°	* 20° - 40°	
24,0	2,5	-	-	-	-	-	24,0
26,0	2,5	-	-	2,1	-	-	26,0
28,0	2,5	-	-	2,1	-	-	28,0
30,0	2,5	2,5	-	2,1	2,1	-	30,0
32,0	2,5	2,5	1,9	2,1	2,1	-	32,0
34,0	2,5	2,5	1,9	2,1	2,1	-	34,0
36,0	2,5	2,4	1,9	2,1	2,1	1,6	36,0
38,0	2,5	2,4	1,9	2,1	2,1	1,6	38,0
40,0	2,5	2,3	1,9	2,1	2,1	1,6	40,0
42,0	2,4	2,3	1,9	2,1	2,1	1,6	42,0
44,0	2,4	2,3	1,9	2,1	2,1	1,6	44,0
46,0	2,3	2,2	1,9	2,1	2,0	1,6	46,0
48,0	2,3	2,2	1,9	2,1	2,0	1,6	48,0
50,0	2,2	2,1	1,9	2,1	2,0	1,6	50,0
52,0	2,1	2,0	1,9	1,8	1,8	1,6	52,0
54,0	2,1	2,0	1,9	1,4	1,4	1,6	54,0
56,0	1,8	1,8	1,7	1,0	1,0	1,6	56,0
58,0	1,4	1,4	1,7	-	-	1,2	58,0
60,0	1,1	1,1	1,6	-	-	-	60,0
62,0	-	-	1,2	-	-	-	62,0
64,0	-	-	0,9	-	-	-	64,0

*Luffing under load • Unter Teillast wippbar • Inclinaison sous charge • Angulación con carga • Brandeggio sotto carico • Изменение вылета под нагрузкой

Load charts • Traglasten • Capacités de levage Capacidades • Capacità • Таблицы грузоподъемности

Swingaway (hydraulic luffing) • Klappspitze (hydraulisch wippbar) • Extension treillis (déport hydraulique)
Plumín (angulable hidráulicamente) • Falcone (brandeggio idraulico) • Складной удлинитель стрелы
(гидравлическое изменение вылета)



74,8 - 80,0 m



12,0 m



8,5 m



360°



35,5 t



EN 13000

m	74,8			80,0			m
	5°	* 5° - 20°	* 20° - 40°	5°	* 5° - 20°	* 20° - 40°	
16,0	8,4	-	-	-	-	-	16,0
18,0	8,4	-	-	6,8	-	-	18,0
20,0	8,4	8,2	-	6,8	-	-	20,0
22,0	8,4	8,2	7,8	6,8	6,7	6,7	22,0
24,0	8,4	8,2	7,7	6,8	6,7	6,7	24,0
26,0	8,0	8,2	7,6	6,8	6,7	6,7	26,0
28,0	7,9	7,9	7,6	6,8	6,7	6,7	28,0
30,0	7,9	7,9	7,4	6,8	6,7	6,7	30,0
32,0	6,9	6,9	7,3	5,8	5,8	6,5	32,0
34,0	5,9	5,9	6,5	4,9	4,9	5,5	34,0
36,0	5,1	5,1	5,6	4,0	4,0	4,6	36,0
38,0	4,3	4,3	4,8	3,3	3,3	3,8	38,0
40,0	3,6	3,6	4,1	2,6	2,6	3,1	40,0
42,0	2,9	2,9	3,4	1,9	1,9	2,4	42,0
44,0	2,3	2,3	2,8	0,9	1,4	1,8	44,0
46,0	1,8	1,8	2,2	-	-	1,3	46,0
48,0	1,3	1,3	1,7	-	-	-	48,0
50,0	-	-	1,2	-	-	-	50,0

*Luffing under load • Unter Teillast wippbar • Inclinaison sous charge • Angulacion con carga • Brandeggio sotto carico • Изменение вылета под нагрузкой



74,8 - 80,0 m



21,0 m



8,5 m



360°



35,5 t



EN 13000

m	74,8			80,0			m
	5°	* 5° - 20°	* 20° - 40°	5°	* 5° - 20°	* 20° - 40°	
20,0	5,0	-	-	4,3	-	-	20,0
22,0	5,0	-	-	4,3	-	-	22,0
24,0	5,0	5,0	-	4,3	-	-	24,0
26,0	5,0	5,0	-	4,3	4,3	-	26,0
28,0	5,0	5,0	-	4,3	4,3	-	28,0
30,0	5,0	4,9	4,1	4,3	4,3	-	30,0
32,0	5,0	4,8	4,1	4,3	4,3	4,0	32,0
34,0	5,0	4,7	4,0	4,3	4,3	4,0	34,0
36,0	4,8	4,6	4,0	4,3	4,3	3,9	36,0
38,0	4,8	4,5	3,9	4,1	4,1	3,9	38,0
40,0	4,3	4,3	3,9	3,4	3,4	3,9	40,0
42,0	3,7	3,7	3,8	2,7	2,7	3,7	42,0
44,0	3,1	3,1	3,8	2,2	2,2	3,0	44,0
46,0	2,6	2,6	3,3	1,6	1,6	2,4	46,0
48,0	2,1	2,1	2,8	1,2	1,2	1,9	48,0
50,0	1,6	1,6	2,3	-	-	1,4	50,0
52,0	1,2	1,2	1,8	-	-	1,0	52,0
54,0	-	-	1,4	-	-	-	54,0
56,0	-	-	1,0	-	-	-	56,0

*Luffing under load • Unter Teillast wippbar • Inclinaison sous charge • Angulacion con carga • Brandeggio sotto carico • Изменение вылета под нагрузкой

Superstructure



Boom

15,6 m to 80,0 m seven section TWIN-LOCK™ boom. Maximum tip height 83,0 m.



Boom elevation

1 cylinder with safety valve, boom angle from -1,5° to +83°.



Load moment and independent anti-two block system

Load moment and independent anti-two block system with audio visual warning and control lever lock-out. These systems provide graphic display of boom angle, length, radius, tip height, relative load moment, maximum permissible load, load indication and warning of impending two-block condition with lock-out hoist function.



Cab

Aluminium, full vision, tiltable (approx. 20°), safety glass, adjustable operator's seat with suspension, engine-dependent hot water heater. Armrest-integrated crane controls. Ergonomically arranged instrumentation and crane operating controls.



Slewing

3 slewing gears with axial piston motors, planetary gear, automatic brake with foot operated release switch for free slew.



Counterweight

54,5 tonnes, consisting of various sections (vehicle width 3,00 m). Hydraulic removal system.



Engine

Mercedes-Benz OM936LA, diesel, 6-cylinders, water cooled, turbocharger, 210 kW at 2200 rpm, (80/1269/EWG- fan right). Max. torque 1150 Nm at 1200 rpm to 1600 rpm. Fuel tank capacity: 220 l. Engine emission: Euromot 4 /EPA / CARB Tier 4 final (non road).

*Mercedes-Benz OM906LA, diesel, 6 cylinders, water cooled, turbocharged, 205kW at 2200 rpm. Max torque 1100Nm at 1400 rpm. Fuel tank capacity: 300 l. Engine emission: EUROMOT 3a / EPA / CARB Tier 3 (non road)



Hydraulic system

2 separate circuits, 1 axial piston variable displacement pump (load sensing), with electronic power limiting control and 1 double gear pump for slewing. Thermostatically controlled oil cooler. Tank capacity: 1200 l.



Control system

Full electronic control of all crane movements using electrical control levers with automatic reset to zero. Integrated with the LMI and engine management system by CAN-BUS. ECOS system with graphic display.



Hoist

Axial piston motor with planetary gear and brake. Drum rotation indicator. Hoist camera and light.



Electrical system

Three-phase alternator 28 V/80 A, 2 batteries 12 V/170 Ah.

* Optional equipment

- Bi-fold swingaway, 12/21 m - with hydraulic offset and luffing under load (5° - 40°), controlled from the crane cab.
- Lattice extension, 37 m - includes 2 x 8 m fixed, non-offsettable sections plus 12/21 m swingaway (see above).
- 2,0 m heavy duty jib (38 t max. capacity) using 4 parts of line.
- Additional 38 tonnes counterweight (total counterweight 92,5 tonnes).
- Auxiliary hoist, self rigging with counterweight.
- Engine-independent hot water heater, with engine pre-heater.
- Boom head camera.
- Boom removal kit.

Carrier



Chassis

Special 6-axle chassis, all-welded torsion-resistant box type construction in high strength steel.



Outriggers

4 double hydraulically telescoping beams with vertical cylinders and outrigger pads. Independent horizontal and vertical movement control on each side of the carrier and from the operators cab. Electronic level indicator with automatic levelling system. Working light for each outrigger beam. Outrigger pad load indicator with read out on superstructure and carrier.



Engine

Mercedes-Benz OM473LA, diesel, 6-cylinders, water cooled, turbocharger, 430 kW at 1700 rpm (80/1269/EWG - fan loose). Max. torque: 2750 Nm at 1300 rpm. Fuel tank capacity: 480 l (installed on superstructure). Engine emission: Euromot 4 / EPA / CARB Tier 4 final (non road).

*Mercedes-Benz OM502LA, 8 cylinders, water cooled, turbocharged, 450 kW at 1800 rpm (80/1269 EWG - fan loose). Max. torque: 2700 Nm at 1300rpm. Fuel tank capacity: 500 l (installed on superstructure). Engine emission: Euromot 3a / EPA / CARB Tier 3 (non road).



Transmission

Allison automatic 4500 SP, 6 forward and 1 reverse speed. Transverse differential locks. Two speed transfer case with inter-axle differential lock.



Drive/Steer

12 x 6 x 12.



Axle lines

6 axle lines. 1, 4 and 5 are driven steering axle lines, the 2nd, 3rd and 6th are steering axle lines.



Suspension

MEGATRAK®. All wheels with independent hydropneumatic suspension and hydraulic lockout. Longitudinal and transverse level control with automatic on-highway levelling system. Range +170 mm/-130 mm. Active suspension control on outrigger control units.



Tyres

12 tyres, 385/95 R25 (14.00 R25).



Steering

Dual circuit, hydraulic power assisted steering with emergency steering pump. Axle lines 1, 2, 5 and 6 steer on highway (steer by wire). Separate electronic hydraulic (steer by wire) steering of the 3rd to 6th axle line for all wheel steering and crabbing.



Brakes

Service brake: pneumatic dual circuit, acting on all wheels, air dryer. Permanent brake: exhaust brake and constant throttle brake.

Parking brake: pneumatically operated spring-loaded brake acting on axle lines 2, 4, 5 and 6.



Cab

Composite designed aluminium and fibre reinforced plastic, 2-man-design, safety glass, driver seat with pneumatic suspension, engine-dependent hot water heater. Complete instrumentation and driving controls. Reversing camera system. Air condition. 12 V plug. Two strobe lights. Fire extinguisher.



Electrical system

Three-phase alternator 28 V/100A, 2 batteries 12 V/170 Ah. Lighting system and signals 24 V.

* Optional equipment

- 12 x 8 x 12 (1, 4, 5, 6 driven).
- Transmission integrated hydraulic retarder.
- 12 tyres, 445/95 R25 (16.00 R25).
- 12 tyres, 525/80 R25 (20.5 R25) - Vehicle width 3,10 m.
- Aluminium rims.
- Folding bunk bed in carrier cab.
- Engine-independent hot water heater, with engine pre-heater.
- Engine shutdown valves (both engines).

*Further optional equipment upon request.

Technische Daten

Kranoberwagen



Teleskopausleger

Von 15,6 m bis 80,0 m ausfahrbarer, siebenteiliger TWIN-LOCK™ Ausleger. Maximale Rollenhöhe 83,0 m.



Wippwerk

1 Zylinder mit Sicherheits-Rückschlagventil. Auslegerverstellwinkel -1,5° bis +83°.



Elektronischer Lastmomentbegrenzer und unabhängiges Hubendschalter System

Elektronischer Lastmomentbegrenzer mit hör- und sichtbarer Vorwarnung sowie automatischer Abschaltung, grafische Anzeige für tatsächliche und zulässige Belastung, Ausladung und diverse Zustände. Unabhängiges Hubendschalter-System mit Abschaltfunktion.



Krankabine

Vollsicht-Aluminium-Kabine, ca. 20° kippbar, Sicherheitsglas, verstellbarer Fahrersitz mit Dämpfung. In Armlehnen integrierte Kransteuereinrichtung. Ergonomisch angeordnete Steuer- und Kontrolleinrichtungen. Motorabhängige Warmwasserheizung.



Drehwerk

3 Drehwerke mit Axialkolbenmotoren, Planetengetriebe, automatische Bremse, Freischaltung über Fußtaster.



Gegengewicht

54,5 t bestehend aus mehreren Teilen (Fahrzeugbreite 3,00 m). Hydraulisches Rüstsystem.



Motor

Mercedes-Benz OM936LA, 6-Zylinder Reihen-Dieselmotor, wassergekühlt mit Abgasturbolader, 210 kW bei 2200 1/min, (80/1269/EWG Ventilator starr) max. Drehmoment 1150 Nm bei 1200 1/min bis 1600 1/min. Kraftstoffbehälter 220 Liter. Motoremission: Euromot 4 / EPA / CARB Tier 4 final (non road).

*Mercedes-Benz OM906LA, 6 Zylinder Diesel, wassergekühlt mit Abgasturbolader, 205 kW bei 2200 min⁻¹. Max. Drehmoment 1100 Nm bei 1400 min⁻¹. Kraftstoffbehälter: 300 l. Motoremission: EUROMOT 3a / EPA / CARB Tier 3 (non road).



Hydrauliksystem

2 separate Kreisläufe, 1 Axialkolben-Verstellpumpe (load sensing) mit elektronischer Grenzlastregelung und 2 Zahnradpumpen für das Drehwerk. Thermostatisch gesteuerter Ölkühler. Tankvolumen: 1200 l Hydrauliköl.



Steuerung

Voll elektronische Steuerung aller Bewegungen mit elektrischen Kreuzsteuerhebeln mit automatischer Nullstellung, verbunden mit der LMB und dem Motormanagement System über einen CAN-BUS. ECOS System mit grafischer Anzeige.



Hubwerk

Axialkolbenmotor mit Planetengetriebe und Bremse. Hubwerksdrehmelder. Hubwerkskamera und Beleuchtung.



Elektrische Anlage

Drehstromlichtmaschine 28 V/80 A, 2 Batterien 12 V/170 Ah.

* Zusatzausrüstung

- Doppelklappspitze 12/21 m Anlenkung 5°- 40°. Aus der Krankabine hydraulisch einstellbar und unter Teillast wippbar.
- Auslegerverlängerung, Gitterkonstruktion 37 m, bestehend aus Doppelklappspitze (siehe oben) und 2 Verlängerungsstücken zu je 8 m.
- 2,0 m Schwerlastspitze (2 rollig, max. 38 t).
- Zusatzgegengewicht 38 t (Gesamtgegengewicht 92,5 t).
- Hilfshubwerk selbstüstend über das Gegengewicht.
- Motorunabhängige Warmwasser-Standheizung mit Motorvorwärmung.
- Auslegerkopfkamera.
- Auslegerdemontage-Set.

Kranunterwagen



Rahmen

6-Achs-Spezialfahrzeug, geschweißte, torsionssteife Kastenkonstruktion aus höchstem Feinkornstahl.



Abstützung

4 hydraulisch doppelt teleskopierbare Schiebeträger mit Abstützzyklindern und Abstützplatten, beidseitig vom Unterwagen und aus der Krankabine einzeln horizontal und vertikal steuerbar. Elektronische Niveauanzeige mit automatischer Nivellierung. Arbeitsscheinwerfer montiert am Abstützträger. Stützdruckanzeige am Unterwagen und Oberwagen.



Motor

Mercedes-Benz OM473LA, 6-Zylinder Reihen-Dieselmotor, wassergekühlt mit Abgasturbolader, 430 kW bei 1700 1/min (80/1269/EWG Ventilator lose), max. Drehmoment 2750 Nm bei 1300 1/min. Kraftstoffbehälter: 480 l (im Oberwagen montiert). Motoremission: Euromot 4 / EPA / CARB Tier 4 final (non road).

*Mercedes-Benz OM502LA, 8 Zylinder, wassergekühlt mit Abgasturbolader, 450 kW bei 1800 min⁻¹ (80/1269/EWG Ventilator lose), max. Drehmoment 2700 Nm bei 1300 min⁻¹. Kraftstoffbehälter: 500 l (im Oberwagen montiert). Motoremission: Euromot 3a / EPA / CARB Tier 3 (non road).



Getriebe

Allison Getriebeautomat 4500 SP, 6 Gänge vorwärts und 1 rückwärts. Querdifferentialsperren. Verteilergetriebe 2 stufig mit Längsdifferentialsperre.



Antrieb/Lenkung

12 x 6 x 12.



Achslinien

6 Achslinien, Achslinie 1, 4 und 5 gelenkt und angetrieben. Achslinien 2, 3 und 6 gelenkt.



Federung

MEGATRAK®. Alle Räder in Einzelradaufhängung, hydropneumatische Federung und hydraulische Blockierung. Neigungsverstellung in alle Richtungen und automatische Straßenfahrniveaueinstellung.

Federweg +170mm/-130mm. Achsanhebung an Abstützungsbedieneinheit.



Bereifung

12 Reifen, Größe 385/95 R25 (14.00 R25).



Lenkung

Zweikreis-Hydraulenkung mit Notlenkpumpe. Während der Straßenfahrt werden die 1., 2., 5. und 6. Achse (steer by wire) gelenkt. Separate elektronisch-hydraulische Lenkung der 3. bis 6. Achslinie für Allradlenkung und Krabbengang.



Bremsen

Betriebsbremse: pneumatische Zweikreisbremse, auf alle Räder wirkend, Lufttrockner. Dauerbremse: Motorklappenbremse mit Konstantdrossel. Feststellbremse: Druckluftbetätigte Federspeicherbremse auf 2., 4., 5. und 6. Achslinie wirkend.



Fahrerhaus

Aluminium- und faserverstärkte Kunststoffkombination, 2-Mann-Fahrerhaus, Sicherheitsglas, luftgedämpfter Fahrersitz, motorabhängige Warmwasserheizung. Kontroll- und Bedieneinrichtung für Fahrbetrieb. Rückfahrkamerasystem. Klimaanlage. 12 V-Anschluß. Zwei Rundumkennleuchten. Feuerlöscher.



Elektrische Anlage

Drehstromlichtmaschine 28 V/100 A, 2 Batterien 12 V/170 Ah, Beleuchtung und Signaleinrichtung 24 V.

* Zusatzausrüstung

- 12 x 8 x 12 (1., 4., 5. und 6. Achse angetrieben).
- Getriebeintegrierter hydraulischer Retarder.
- 12 Reifen, Größe 445/95 R25 (16.00 R25).
- 12 Reifen, Größe 525/80 R25 (20.5 R25) - Fahrzeugbreite 3,10 m.
- Aluminiumfelgen.
- Klappliege im Fahrerhaus.
- Motorunabhängige Warmwasser-Standheizung mit Motorvorwärmung.
- Lufteinlassabsperrventil (AMOT).

*Weitere Zusatzausrüstungen auf Anfrage.

Superstructure



Flèche

Flèche sept éléments de 15,6 m à 80,0 m, à télescopage TWIN-LOCK™. Hauteur maximum de tête de flèche 83,0 m.



Relevage

1 vérin avec clapet anti-retour, angle de relevage de - 1,5° à +83°.



Contrôleur d'état de charge et dispositif de fin de course haute crochet indépendant

Équipements électroniques de contrôle de charge et de fin de course haute crochet indépendants avec dispositifs de signalisation sonore et visuelle et de coupure des mouvements. Affichage graphique d'angle et de longueur de flèche, de portée, de hauteur de tête de flèche, de moment relatif, de charge maximum autorisée, d'état de charge et d'approche de fin de course haute crochet avec coupure du mouvement de montée de treuil.



Cabine

Cabine Aluminium, inclinable (angle d'inclinaison environ 20°), largement vitrée, avec vitrage de sécurité, hydraulique suspendu et chauffage à eau chaude alimenté par le moteur. Disposition ergonomique des commandes de grue intégrées dans les accoudoirs et de l'instrumentation.



Orientation

Dispositif d'orientation triple avec moteurs hydrauliques à pistons axiaux, frein à serrage automatique et commande d'orientation libre au pied.



Contrepoids

Contrepoids modulaire de 54,5 t (largeur du véhicule 3,00 m). Système de dépose hydraulique.



Moteur

Moteur Mercedes-Benz OM936LA, diesel, 6 cylindres, refroidi à l'eau, turbocompresseur, 210 kW à 2200 tr/min (80/1269/CEE - ventilateur rigide). Couple maxi 1150 Nm de 1200 t/min à 1600 t/min. Capacité du réservoir : 220 l. Émissions du moteur : Euromot 4 / EPA / CARB Tier 4 final (usage non routier).

*Moteur Diesel Mercedes-Benz OM906LA, 6 cylindres suralimenté, refroidi par eau et développant 205 kW à 2200 min-1. Couple maxi 1100 Nm à 1400 min-1. Capacité du réservoir : env. 300 l. Conformité aux normes de pollution EUROMOT 3a / EPA / CARB Tier 3 (tout terrain).



Système hydraulique

2 circuits indépendants, 1 pompe à pistons axiaux avec système (load sense) de contrôle de charge et 1 pompe double à engrenages pour l'orientation. Refroidisseur d'huile à commande thermostatique. Capacité du réservoir : 1200 l.



Commande

Commandes de grue électroniques par manipulateurs électriques avec retour au neutre automatique. Ces commandes sont reliées au contrôleur d'état de charge et au dispositif de gestion du moteur thermique par système CAN-BUS. Système ECOS avec affichage graphique.



Treuil de levage

Treuil avec tambour rainuré, réducteur à planétaires, frein multidisque, moteur à pistons axiaux et indicateur de rotation. Caméra et éclairage du treuil.



Installation électrique

Alternateur triphasé 28 V/80 A et 2 batteries 12 V/170 Ah.

* Equipements optionnels

- Extension treillis à repliage latéral double de 12/21 m - avec déport hydraulique et inclinaison sous charge (5° - 40°), commandés depuis la cabine.
- Extension treillis de 37 m constituée d'extensions treillis double de 12/21 m plus deux éléments intermédiaires de 8 m.
- Extension treillis 2,0 m, 2 réas, pour levages lourds (max. 38 t).
- Contrepoids supplémentaire de 38 t (Contrepoids total 92,5 t).
- Treuil auxiliaire, auto-câblage avec contrepoids.
- Chauffage auxiliaire à eau chaude indépendant avec dispositif de préchauffage moteur.
- Caméra de tête de flèche.
- Equipement de dépose de flèche.

Porteur



Châssis

Porteur spécial, « 6 lignes d'essieux », mécanosoudé, type caisson, en acier à haute limite élastique.



Calage

4 poutres à télescopage hydraulique, avec vérins et patins d'appui. Commande indépendante des mouvements verticaux et horizontaux sur les deux côtés du porteur et depuis la cabine de l'opérateur. Indicateur de mise à niveau électronique avec système de mise à niveau automatique. Projecteur de travail sur les bras de télescopage. Indicateur de charge des patins d'appui avec mesure affichée sur la superstructure et le châssis.



Moteur

Moteur Mercedes-Benz OM473LA, diesel, 6 cylindres, refroidi à l'eau, turbo-compresseur, 430 kW à 1700 tr/min (80/1269/CEE - ventilateur libre). Couple maxi : 2750 Nm à 1300 tr/min. Capacité du réservoir : 480 l (installé sur superstructure). Émissions du moteur : Euromot 4 / EPA / CARB Tier 4 final (usage non routier).

*Moteur Mercedes-Benz OM502LA, 8 cylindres suralimenté, refroidi par eau et développant 450 kW à 1800 min-1 (80/1269 EWG - ventilateur débrayable). Couple maxi 2700 Nm à 1300 min-1. Capacité du réservoir : env. 500 l. embarqué sur la superstructure. Conformité aux normes de pollution Euromot 3a / EPA / CARB Tier 3 (tout terrain).



Boîte de vitesses

Boîte de vitesses automatique Allison 4500 SP. 6 rapports de marche avant et 1 rapport de marche arrière. Différentiel inter-roues. Boîte de transfert avec verrouillage longitudinal du différentiel.



Direction/Transmission

12 x 6 x 12.



Lignes d'essieux

6 lignes d'essieux. Lignes d'essieux 1, 4, et 5 directrices et motrices, lignes d'essieux 2, 3 et 6 directrices.



Suspension

Suspension hydropneumatique à roues indépendantes MEGATRAK® et dispositif de verrouillage. Commandes de mise à niveau longitudinal et transversal. Dispositif de mise à niveau automatique en position route. Débattement : +170 mm/-130 mm. Contrôle de suspension actif sur les unités de commande de calage.



Pneumatiques

12 pneumatiques 385/95 R25 (14.00 R25).



Direction

Direction assistée à double circuit et pompe de secours. Lignes d'essieux 1, 2, 5 et 6 directionnelles sur route (direction par câble). Direction hydraulique et électronique indépendante (direction par câble) direction indépendante pour les lignes d'essieux 3 et 6 pour réduction du diamètre de braquage et déplacement latéral (marche en crabe).



Freins

Frein de service pneumatique à double circuit agissant sur toutes les roues. Dessiccateur. Ralentisseur par clapet sur échappement et décalage de la distribution. Frein de stationnement à ressorts commandé pneumatiquement agissant sur les lignes d'essieux 2, 4, 5 et 6.



Cabine

Plastique renforcé par fibre de verre et aluminium. Cabine bi-place avec vitrage de sécurité, suspension pneumatique suspendu, chauffage à eau chaude alimenté par le moteur et instrumentation complète pour le contrôle et la conduite de la machine. Caméra de recul. Air conditionné. Batterie 12 V. Deux éclairages troscopiques. Extincteur.



Installation électrique

Alternateur triphasé 28 V/100 A et 2 batteries 12 V/170 Ah, équipement d'éclairage et de signalisation routière : 24 V.

* Equipements optionnels

- Configuration 12 x 8 x 12 (1, 4, 5, 6, motrices).
- Ralentisseur hydraulique intégré au système de transmission.
- 12 pneumatiques 445/95 R25 (16.00 R25).
- 12 pneumatiques 525/80 R25 (20.5 R25) - Largeur du véhicule 3,10 m.
- Jantes aluminium.
- Banquette repliable dans la cabine porteur.
- Chauffage auxiliaire à eau chaude indépendant avec dispositif de préchauffage moteur.
- Clapets de coupure d'air pour les 2 moteurs.

* Autres équipements optionnels sur demande.

Características

Superestructura



Pluma

De 15,6 m a 80,0 m siete tramos de telescopaje TWIN-LOCK™. Altura máxima en punta 83,0 m.



Elevación de pluma

Un cilindro con válvula de seguridad. Angulo de pluma desde -1,5° hasta +83°.



Sistema Indicador del Momento de Carga y de Final de Carrera del Gancho

Sistema Indicador del Momento de Carga y de Final de Carrera del Gancho, con alarma audio-visual y bloqueo automático de las palancas. Este sistema incluye pantalla gráfica con indicación de ángulo de pluma, longitud, radio, altura de cabeza de pluma, momento de carga relativo, carga máxima permisible, carga real y alarma de fin de carrera del gancho con bloqueo del movimiento de elevación.



Cabina

De **Aluminio** basculable (aprox. 20°), amplia visibilidad, cristales de seguridad, asiento del operador ajustable y con hidráulica suspensión. Calefacción dependiente del motor por agua caliente. Controles de la grúa integrados en el apoya-brazos. Controles de operación de la grúa e instrumentación ergonómicamente situados.



Giro

Tres reductores de giro con motores de pistón axial, engranaje planetario, freno automático con interruptor de desconexión accionado por pedal para giro libre.



Contrapeso

De 54,5 Tm, compuesto de varios bloques (Anchura del vehículo: 3,00 m). Sistema hidráulico para desmontaje.



Motor

Mercedes-Benz OM936LA, diésel, 6 cilindros, refrigerado por agua, turbo, 210 kW a 2200 rpm, (80/1269/CEE- ventilador fijo). Par máximo 1150 Nm entre 1200 rpm y 1600 rpm. Capacidad del depósito de combustible: 220 l. Emisiones del motor: Euromot 4 /EPA / CARB Tier 4 final (fuera de la carretera). *Diesel Mercedes Benz OM906LA, 6 cilindros, refrigerado por agua y turboalimentado, 205 Kw a 2200 r.p.m. Par máximo: 1100 Nm, a 1400 r.p.m. Capacidad del depósito de Combustible: 300 litros. Emisión de gases: Según normas EUROMOT 3a / EPA / CARB Tier 3 (fuera de carretera).



Sistema hidráulico

2 circuitos separados, 1 bomba variable de desplazamiento con pistones axiales (con sensor de carga), con control electrónico de limitación de potencia y 1 bomba de doble marcha para la rotación. Refrigerador del aceite controlado por termostato. Capacidad del depósito: 1200 l.



Sistema de control

Control completamente electrónico de todos los movimientos de la grúa, usando palancas de control eléctrico con retorno automático a cero. Integrado con el Limitador de Cargas y el sistema de control del motor por un equipo "CAN-BUS". Sistema ECOS con indicador gráfico.



Cabrestante

Motor de pistón axial con engranaje planetario y freno. Indicador de rotación del tambor. Luz y cámara de cabrestante.



Sistema eléctrico

Trifásico con alternador 28 V/80A, dos baterías de 12 V/170 Ah.

* Equipos opcionales

- Plumín articulado en 2 secciones, 12/21 m - con angulación fija y variable, con carga (5°- 40°) de accionamiento hidráulico.
- Extensión de pluma, de celosía, de 37 m incluyendo el plumín de 12/21 m (el de arriba) más 2 extensiones de 8 m.
- Plumín de 2,0 m con 2 poleas para cargas pesadas (máx. 38 t).
- Contrapeso adicional de 38 Tm. (Contrapeso total 92,5 Tm.)
- Cabrestante auxiliar, reglaje autónomo con contrapeso.
- Calefacción independiente del motor por agua caliente, con precalentamiento del motor.
- Cámara principal de pluma.
- Kit de retirada de la bomba.

Chasis



Bastidor

Chasis especial de seis ejes de construcción soldada tipo cajón, resistente a la torsión, en acero de alta resistencia.



Estabilizadores

Cuatro vigas telescópicas hidráulicas con cilindros verticales y placas de apoyo. Controles independientes para los movimientos horizontales y verticales, con controles en ambos lados del chasis y desde la cabina del operador. Indicador de nivel electrónico con sistema de nivelación automática. Luz de trabajo en cada estabilizador. Indicador de carga de la plataforma del estabilizador con lectura de superestructura y chasis.



Motor

Mercedes-Benz OM473LA, diésel, 6 cilindros, refrigerado por agua, turbo, 430 kW a 1700 rpm, (80/1269/CEE- ventilador suelto). Par máximo: 2750 Nm a 1300 rpm. Capacidad del depósito de combustible: 480 l (instalado en la superestructura). Emisiones del motor: Euromot 4 / EPA / CARB Tier 4 final (fuera de la carretera).

*Mercedes Benz OM502LA, 8 cilindros, refrigerado por agua y turboalimentado, 450 Kw a 1800 r.p.m. (80/1269 EWG - ventilador desconectado), par máximo: 2700 Nm, a 1300 r.p.m. Capacidad del Depósito de Combustible: 500 litros montado en la superestructura. Emisión de gases: Según normas Euromot 3a / EPA / CARB Tier 3 (fuera de carretera).



Transmisión

ALLISON automática 4500 SP, 6 velocidades adelante y 1 atrás. Candado de diferencial. Caja de transferencia con 2 velocidad y bloqueo diferencial entre ejes.



Tracción/Dirección

12 x 6 x 12.



Ejes

6 ejes en línea. Ejes 3, 4 y 5 motrices y directrices. Ejes 2, 3 y 6 directrices.



Suspensión

MEGATRAK®. Todas las ruedas con suspensión hidroneumática independiente y bloqueo hidráulico. Control de nivel longitudinal y transversal con sistema de nivelación automática en carretera. Desplazamiento +170 mm / -130 mm. Control de la suspensión activo en las unidades de control del estabilizador.



Neumáticos

12 neumáticos, 385/95 R25 (14.00 R25).



Dirección

Dirección servo-asistida con doble circuito con bomba de dirección de emergencia. Los ejes 1, 2, 5 y 6 son directrices para circular por carretera (dirección por cable). Dirección separada hidráulica electrónica separada (dirección por cable) de los ejes 3 y 6 para la dirección en todas las ruedas y conducción tipo cangrejo.



Frenos

Frenos de servicio: Neumático con doble circuito, actuando sobre todas las ruedas, secador de aire. Freno continuo: Freno sobre el escape, con estrangulamiento continuo. Freno de Aparcamiento: Operado neumáticamente y aplicado por muelle sobre los ejes 2, 4, 5 y 6.



Cabina

Plástico reforzado de fibra y aluminio compuesto, para dos personas, cristales de seguridad, asientos del conductor y pasajero con neumática suspensión, calefacción por agua caliente del motor. Controles e instrumentación para conducción del vehículo. Sistema de cámara invertida. Aire acondicionado. Conector de 12 V. Dos luces estroboscópicas. Extintor.



Sistema eléctrico

Trifásico, alternador de 28 V/100A, 2 baterías 12 V/170 Ah. Sistema de alumbrado y señalización a 24 V.

* Equipos opcionales

- 12 x 8 x 12 (1, 4, 5, 6 motrices).
- Retardador hidráulico integrado en la transmisión.
- 10 neumáticos 445/95 R25 (16.00 R25).
- 10 neumáticos 525/80 R25 (20.5 R25) - Anchura del vehículo: 3,10 m.
- Llantas de aluminio.
- Litera plegable en la cabina del chasis.
- Calefacción independiente del motor por agua caliente, con precalentamiento del motor.
- Válvula de apagado del motor (para ambos motores).

* Sigüientes equipos bajo demanda.

Torretta



Braccio

Da 15,6 a 80,0 metri; sette sezioni con sfilamento TWIN-LOCK™. Massima altezza in punta 83,0 metri.



Sollevamento Braccio

Un cilindro con valvola di sicurezza, angolo del braccio da -1,5° a +83°.



Limitatore di carico

Limitatore di carico e finecorsa con allarme visivo e sonoro e blocco delle leve di comando. Il sistema è provvisto di display grafico elettronico riportante l'angolo e la lunghezza del braccio, il raggio di lavoro, l'altezza di lavoro, il momento, il carico massimo ammissibile e il carico sollevato. Allarme per prevenire il fine corsa con blocco delle funzioni dell'argano. Limitatore area di lavoro di serie.



Cabina

Costruita in alluminio con grande visibilità, ribaltabile idraulicamente di circa 20° montata a sinistra, cristalli di sicurezza, parabrezza anteriore ribaltabile, porta scorrevole, aletta e tendina parasole, abbaino con tergicristallo, riscaldamento (dipendente dal motore), aria condizionata, bocchette per la ventilazione e losbrinamento, sedile deluxe con sospensione idraulica, poggiatesta e braccioli con joystick di controllo integrati. Strumentazione e pannello di comando disposti in maniera ergonomica, 2 faretti disposti sul frontale della cabina, estintore da 5 Kg incluso montato dentro la cabina, Stereo radio/CD player.



Rotazione

Rotazione continua a 360°, 3 riduttori planetari con motori a pistone assiali, freno automatico, freno a pedale azionabile come controllo rotazione.



Contrappeso

Da 54,5 tonnellate realizzato in 6 sezioni (larghezza 3,00 metri); sistema di allestimento idraulico.



Motore

Motore diesel a 6 cilindri Mercedes-Benz OM936LA, raffreddato ad acqua, sovralimentato, potenza 210 kW a 2200 rpm (80/1269/CEE ventola fissa). Coppia massima: 1150 Nm a 1200 rpm fino a 1600 rpm. Capacità serbatoio: 220 l. Livello di emissioni secondo le norme: Euromot 4/EPA/CARB Tier 4 final (motori non stradali).

* Mercedes Benz OM906LA diesel 6 cilindri raffreddato ad acqua, sovralimentato, potenza di 205 kW a 2200 giri. Coppia massima 1100 Nm a 1400 giri. Capacità del serbatoio 300 litri. Emissione gassosa allo scarico nei limiti: EUROMOT 3a / EPA / CARB Tier 3 (motori non stradali).



Impianto idraulico

2 circuiti indipendenti, 1 pompa a portata variabile a pistone assiali (load sensing), con controllo elettronico della potenza e 1 pompa a doppio ingranaggio per la rotazione. Radiatore dell'olio a controllo termostatico. Capacità serbatoio olio idraulico: 1200 l.



Comandi

Controllo completamente elettronico di tutti i movimenti della gru (joystick elettronici) integrato con il sistema LMI (Limitatore di carico) e con il sistema CAN-BUS di controllo del motore. Sistema ECOS con display grafico.



Argano

Motore a pistoni assiali con riduttore planetario e freno a dischi multipli automatico. Indicatore della rotazione dell'argano. Videocamera sull'argano con luce di lavoro inclusa.



Impianto elettrico

Alternatore trifase 28V/80 A, due batterie 12V 170Ah.

* Accessori opzionali

- Prolunga tralicciata pieghevole 12/21 metri con brandeggio idraulico (5° - 40°) controllato dalla cabina gru.
- Prolunga tralicciata da 37 metri composta dal pieghevole 12/21 metri (vedi sopra) e 2 elementi intermedi fissi da 8 metri cad.
- Jib da prefabbricati da 2,0 m con 2 carrucole (portata massima 38 t).
- Contrappeso supplementare da 38 t (contrappeso totale 92,5 t).
- Argano ausiliario automontante con il contrappeso.
- Riscaldatore diesel della cabina indipendente dal motore che funge anche da preriscaldatore del motore con timer 24 ore.
- Telecamera a colori montata sulla testa del braccio con display LCD in cabina torretta.
- Kit di rimozione del braccio.

Carro



Telaio

Telaio speciale a 6 assi completamente saldato in acciaio scottato ad alta resistenza alla torsione.



Stabilizzatori

4 travi orizzontali telescopiche con cilindri verticali e piattini stabilizzatori. Controllo dei movimenti verticale ed orizzontale indipendente su ogni lato del carro e dalla cabina dell'operatore. Indicatore elettronico del livello, Indicatore del carico su ciascuna trave visibile dai pannelli di comando laterali del carro o dalla sovrastruttura, luci di lavoro su ciascuno stabilizzatore.



Motore

Motore diesel a 6 cilindri Mercedes-Benz OM473LA, raffreddato ad acqua, sovralimentato, potenza 430 kW a 1700 rpm (80/1269/CEE ventola con giunto). Coppia massima: 2750 Nm a 1300 rpm. Capacità serbatoio: 480 l (montato sulla sovrastruttura). Livello di emissioni secondo le norme: Euromot 4/EPA/CARB Tier 4 final (motori non stradali)

*Mercedes Benz OM502LA 8 cilindri raffreddato ad acqua, sovralimentato, potenza di 450 kW a 1800 giri (80/1269 EWG fan loose). Coppia massima 2700 Nm a 1300 giri. Capacità del serbatoio 500 litri (installato sulla sovrastruttura). Emissione gassosa allo scarico nei limiti: Euromot 3a / EPA / CARB Tier 3 (motori non stradali).



Cambio

Cambio automatico Allison 4500 SP, 6 marce avanti più 1 retromarcia. Bloccaggio differenziale trasversale. Riduttore ripartitore a 2 velocità.



Trazione/Sterzo

12 x 6 x 12.



Assali

6 assi: primo, quarto e quinto sterzanti e traenti. Secondo, quarto e sesto solo sterzanti.



Sospensioni

MEGATRAK*. Tutte le ruote sono montate su sospensioni idropneumatiche indipendenti con bloccaggio idraulico. Controllo del livellamento longitudinale e trasversale con livellamento automatico per la circolazione stradale. Corsa +170mm/-130mm. Controllo del livellamento delle sospensioni anche tramite i pannelli laterali di comando degli stabilizzatori.



Pneumatici

12 pneumatici montati in singolo 385/95 R25 (14.00 R25).



Sterzo

Doppio circuito, Servoassistito idraulicamente con pompa di emergenza. Assi 1 2 5 e 6 comandati dallo sterzo durante la marcia. Comando separato Sterzata idraulica (steer by wire) gestita elettronicamente per assi dal 3 al 6 per eseguire la sterzata combinata e a granchio.



Freni

Freno di servizio: pneumatico a doppio circuito, agente su tutte le ruote, con essiccatore dell'aria. Freno motore, ABS. Freno di parcheggio: con molle precaricate a comando pneumatico agente sugli assi 2,4, 5 e 6.



Cabina

Design composito in alluminio e plastica rinforzata con fibre di vetro. Due posti, sedili totalmente regolabili e con sospensione pneumatica, cinture di sicurezza. Cristalli di sicurezza, impianto di riscaldamento, specchietti laterali riscaldati, tachigrafo, contachilometri, strumentazione completa per tutte le funzioni del carro. Stereo radio/CD player, estintore da 5 Kg montato in cabina, Aria condizionata, 2 luci stroboscopiche di serie. Attacco 12V in cabina. Videocamera per la manovra in retromarcia.



Impianto elettrico

Alternatore trifase 28V/100 A, due batterie 12V 170Ah. Luci e segnali a 24 V.

* Accessori opzionali

- 12 x 8 x 12 (assi 1, 4, 5, 6 traenti).
- Retarder idraulico integrato nella trasmissione.
- Ruote da 445/95 R25 (cerchione 16.00 R25).
- Ruote da 525/80 R25 (cerchione 20.5 R25).
- Cerchioni in alluminio.
- Cuccetta ribaltabile in cabina guida.
- Riscaldatore diesel della cabina indipendente dal motore che funge anche da preriscaldatore del motore con timer 24 ore.
- Terzo sedile nella cabina guida.
- Valvole di disinserimento del motore (per entrambi i motori).
- Vano di stivaggio posteriore per l'attrezzatura di allestimento

* Altri a richiesta.

Технические характеристики

Крановая установка



Стрела

Семисекционная стрела TWIN-LOCK™ 15,6 - 80,0 м.
Максимальная высота оголовка стрелы 83,0 м.



Подъем стрелы

1 цилиндр с предохранительным клапаном, угол подъема от -1,5° до +83°.



Ограничитель грузовой момент и независимая система блокировки при подъеме

Ограничитель грузовой момент и ограничитель высоты подъема крюка с звуковой и визуальной сигнализацией и блокировкой органов управления. Эти системы выводят на дисплей угол наклона стрелы, длину, радиус, высоту оголовка стрелы, относительный грузовой момент, максимально допустимую нагрузку, текущую нагрузку и предупреждение о возможности перегруза, которое повлечет за собой блокировку управления краном.



Кабина

Кабина: **Алюминиевая**, с круговым обзором, наклоняемая (примерно 20°), безосколочное стекло, регулируемое место оператора с подвеской, устройство для обогрева водой с подогревом от двигателя. Органы управления краном встроены в подлокотник. Эргономичная приборная панель и система управления краном.



Поворот

3 поворотных механизма с аксиально-поршневыми гидравлическими двигателями, планетарной передачей, автоматическим тормозом с ножным управлением поворотом.



Противовес

54,5 тонн, состоящий из различных секций (ширина крана 3,00 м).
Гидравлическая система монтажа противовесов.



Двигатель

Mercedes-Benz OM936LA, дизель, 6 цилиндров, водяное охлаждение, турбокомпрессор, 210 кВт при 2200 об/мин, (80/1269/EWG - вентилятор без возможности замены). Максимальный крутящий момент 1150 Н.м при оборотах от 1200 до 1600 об/мин. Емкость топливного бака: 220 л. Выбросы газов двигателем: Euromot 4 / EPA / CARB Tier 4 final (внедорожная техника).

*Mercedes-Benz OM906LA, дизельный, 6-цилиндровый, с водяным охлаждением, с турбонагнетателем, 205 кВт при 2200 об/мин. Макс. крутящий момент: 1100 Нм при 1400 об/мин. Емкость топливного бака: 300 л. Выбросы двигателя: EUROMOT 3a / EPA / CARB Tier 3 (не дорожный).



Гидравлическая система

2 отдельных контура, 1 аксиально-поршневой насос с переменным рабочим объемом (в зависимости от нагрузки), с электронным ограничителем мощности и 1 насосом со сдвоенной зубчатой передачей для поворота крана. Охлаждитель масла, регулируемый с помощью термореле. Емкость бака: 1200 л.



Система управления

Полностью электронная система управления движением крана с электрорычагами управления и с автоматическим возвратом в нейтральное положение. Эта система соединена с локальным интерфейсом управления и системой управления работой двигателя при помощи шины CAN-BUS. Система ECOS снабжена графическим дисплеем.



Лебедка основного подъема

Аксиально-поршневой гидромотор с планетарной передачей и тормозом. Индикатор вращения барабана. Камера лебедки и освещение.



Электросистема

Трехфазный генератор переменного тока 28 В/80 А, 2 батареи 12 В/170 А-ч.

- Дополнительное оборудование (по выбору)
- Складной удлинитель стрелы 12/21 м, с гидравлическим регулированием высоты стрелы и с возможностью управления под нагрузкой (5° - 40°), управляемый из кабины оператора.
- Удлинитель стрелы, 37 м - включает 2 x 8 м промежуточные вставки и 12/21 м Складной удлинитель стрелы (см. выше).
- Наконечник, увеличивающий грузоподъемность 2,0 м (макс. грузоподъемность 38 т), использующий 4 части запасовки.
- Дополнительный противовес 38 т (суммарная масса противовеса 92,5 т).
- Вспомогательная лебедка, автоматическая с противовесом.
- Независимое от двигателя устройство для обогрева горячей водой с предварительным нагревом от двигателя.
- Камера оголовка стрелы.
- Комплект для демонтажа стрелы.

Тягач



Шасси

Специальное 6-осное шасси: цельносварное, устойчивое к кручению, коробчатого типа, выполненное из высокопрочной стали.



Выносные опоры

4 двойные балки с гидравлическим способом телескопирования с вертикальными цилиндрами и основаниями выносных опор. Независимый контроль горизонтального и вертикального передвижения с каждой стороны тягача и из кабины оператора. Электронный индикатор уровня с автоматической системой выравнивания. Рабочее освещение каждой выносной опоры. Индикатор нагрузки на подушку выносной опоры со считыванием данных на крановой установке и ходовой части.



Двигатель

Mercedes-Benz OM473LA, дизель, 6 цилиндров, водяное охлаждение, турбокомпрессор, 430 кВт при 1700 об/мин, (80/1269/EWG - вентилятор с возможностью замены). Максимальный крутящий момент: 2750 Нм при 1300 об/мин. Емкость топливного бака: 480 л (установлен на крановой установке). Выбросы газов двигателем: Euromot 4 / EPA / CARB Tier 4 final (внедорожная техника).

*Mercedes-Benz OM502LA, 8-цилиндровый, с водяным охлаждением, с турбонагнетателем, 450 кВт при 1800 об/мин. (80/1269 EWG - сменный вентилятор). Макс. крутящий момент: 2700 Нм при 1300 об/мин. Емкость топливного бака: 500 л (на крановой установке). Выбросы двигателя: Euromot 3a / EPA / CARB Tier 3 (не дорожный).



Трансмиссия

Allison automatic 4500 SP 6 передних и 1 задняя передача. Поперечная блокировка дифференциала. Двухступенчатая раздаточная коробка с межосевым механизмом блокировки дифференциала.



Ведущие / Управляемые оси

12 x 6 x 12.



Оси

6 осей. 1, 4 и 5 - ведомые управляемые оси (оси управления поворотом). 2, 3 и 6 - управляемые оси.



Подвеска

MEGATRAK®. Подвеска всех колес гидропневматическая с гидравлической блокировкой. Контроль продольного и поперечного уровня с автоматической системой выравнивания на дороге. Диапазон +170 мм/-130 мм. Контроль активной подвески на блоках управления стрелой.



Шины

12 шин, 385/95 R25 (14.00 R25).



Рулевое управление

Двухконтурная гидравлическая схема управления поворотами с аварийным насосом системы управления. Оси 1, 2, 5 и 6 управляют движением по дороге (управление при помощи электроники). Раздельное электронное гидравлическое управление 3, 4, 5 и 6 осями для всех управляемых колес.



Тормоза

Рабочая тормозная система: пневматическая двухконтурная, с работой на все колеса, осушитель воздуха. Стояночный тормоз: пневматически управляемый пружинный тормоз на 2, 4, 5 и 6 осях.



Кабина

Композитный алюминий и упрочненная волокнистая пластмасса. на 2 человека, безосколочное стекло, водительское место с пневматической подвеской, независимое от двигателя устройство подогрева горячей водой. Органы отображения информации и управления краном. Система обратной камеры. Кондиционирование воздуха. Разъем 12 В. Два проблесковых маяка.



Электросистема

Трехфазный генератор переменного тока 28 В/100А, 2 батареи 12 В/170 А-ч. Система освещения и сигнализации 24 В.

- * Дополнительное оборудование (по выбору)
- 12 x 8 x 12 (1, 4, 5, 6 - ведомые).
- Гидравлический замедлитель, интегрированный в трансмиссию.
- 12 шин, 445/95 R25 (16.00 R25).
- 12 шин, 525/80 R25 (20.5 R25) - Ширина транспортного средства 3,10 м.
- Алюминиевые обода.
- спальное место в кабине.
- Независимое от двигателя устройство для обогрева горячей водой с предварительным нагревом от двигателя.
- Клапаны останова двигателя (для обоих двигателей).

* Прочее дополнительное оборудование предоставляется по запросу.

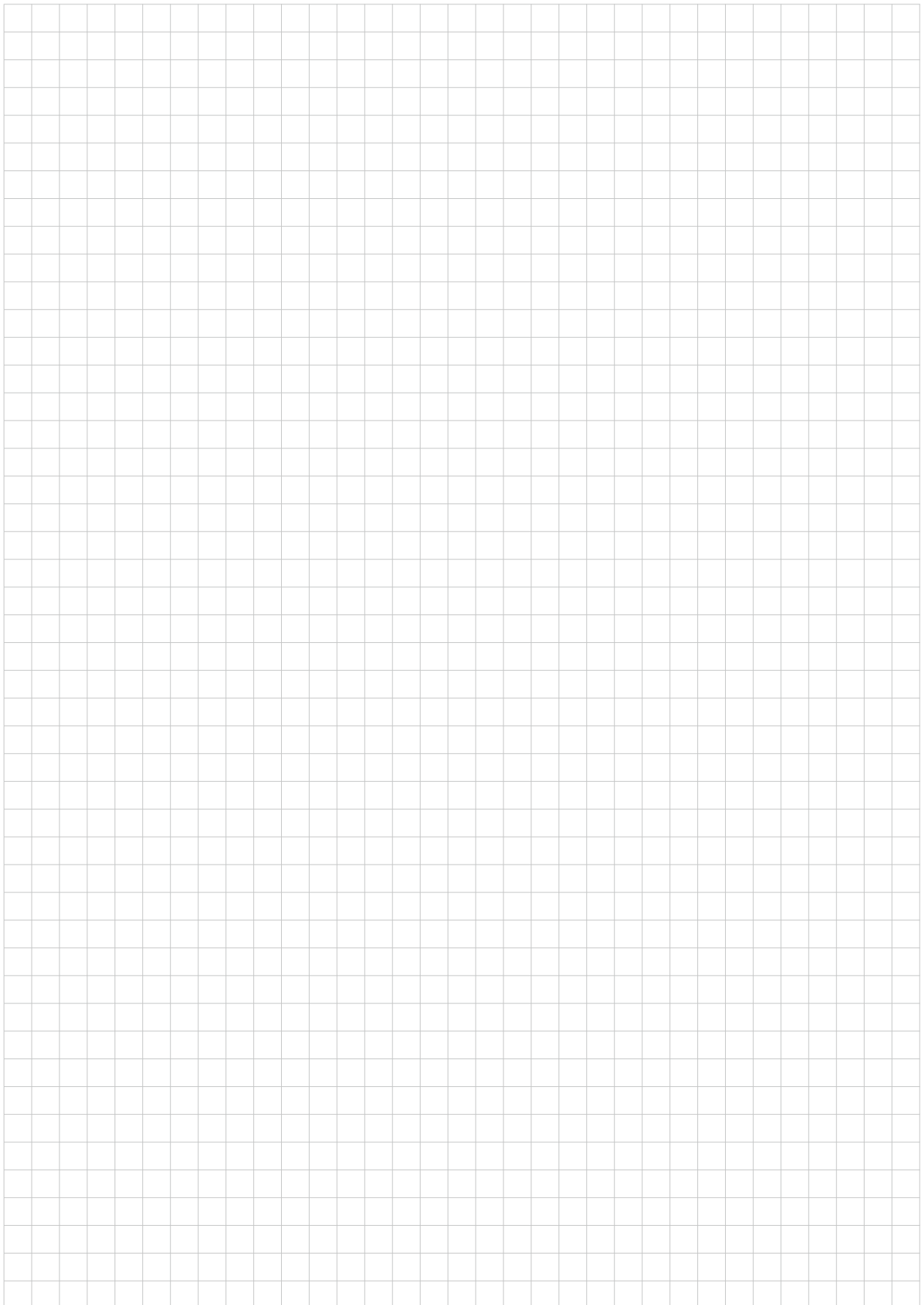

Load charts • Traglasten • Capacités de levage Capacidades • Capacità • Таблицы грузоподъемности

The lifting capacities correspond to EN 13000:2010-10.

The lifting capacities likewise fulfil the requirements of ISO 4305 and DIN 15019, Part 2, with regard to stability, and DIN 15018, Part 3, and FEM 5004 with regard to strength.

The lifting capacities are given in tonnes.

Lifting capacity = Payload + weight of hook block and suspending device.

The lifting capacities for the main boom only apply with the jib dismantled.

Lifting capacities > 179 t require additional equipment.

Lifting capacities > 190 t require special equipment.

The right is reserved to modify the load-carrying capacities.

Note: The details in this brochure serve only as general information. The determinant values for the operation of the crane are the lifting capacity tables belonging to it and the operating instructions.

Lifting capacities are indicated by boom length for different levels of extension. The actual boom length will be in accordance with the selected configuration for boom extension.

Die Tragfähigkeiten entsprechen EN 13000:2010-10.

Die Tragfähigkeitswerte erfüllen ebenfalls die Anforderungen von ISO 4305 und DIN 15019 Teil 2 bezüglich Standsicherheit sowie von DIN 15018 Teil 3 und FEM 5004 bezüglich Festigkeit.

Die Tragfähigkeitswerte sind in Tonnen angegeben.

Tragfähigkeit = Nutzlast + Gewicht der Hakenflasche und Anschlagmittel.

Die Tragfähigkeitswerte für den Hauptausleger gelten nur bei demontierten Spitzenauslegern.

Die Tragfähigkeitswerte > 179 t erfordern eine Zusatzausrüstung.

Die Tragfähigkeitswerte > 190 t erfordern eine Sonderausrüstung.

Änderung der Tragfähigkeiten vorbehalten.

Anmerkung: Die Daten dieser Broschüre dienen nur zur allgemeinen Information. Maßgebend für den Betrieb des Kranes sind die zugehörigen Tragfähigkeitstabellen und die Bedienungsanleitung.

Die Traglastwerte sind aus unterschiedlichen Teleskopierungen pro Auslegerlänge zusammengefasst. Die tatsächliche Auslegerlänge kann variieren.

Les capacités de levage sont conformes à la norme EN 13000:2010-10.

Les capacités de levage respectent également les exigences des normes ISO 4305 et DIN 15019, paragraphe 2, relatives à la stabilité, ainsi que celles des normes DIN 15018 paragraphe 3 et FEM 5004 relatives à la résistance.

Les capacités de levage sont exprimées en tonnes.

Capacité = charge utile + poids du crochet et du dispositif d'élévation.

Les capacités de levage de la flèche principale ne sont valables que lorsque la fléchette est démontée.

Des capacités de levage > 179 tonnes exigent l'utilisation d'un dispositif supplémentaire.

Des capacités de levage > 190 tonnes exigent l'utilisation d'un dispositif spécial.

Le constructeur se réserve le droit d'apporter des modifications à ces capacités de levage.

Remarque : Les données de cette brochure ne sont fournies qu'à titre d'information générale. La manipulation de la grue nécessite l'étude des tableaux de capacité et la lecture des guides d'utilisation correspondants.

Les capacités de levage sont données par longueur de flèche pour différents niveaux de télescopage. Les longueurs de flèche réelles peuvent varier.

Las capacidades de carga corresponden a EN 13000:2010-10.

Asimismo los valores de carga cumplen las disposiciones de las normas ISO 4305 y DIN 15019, 2.ª parte, respecto a la estabilidad, y DIN 15018, 3.ª parte, y FEM 5004 respecto a la fuerza.

Los valores de carga se dan en toneladas.

Capacidad de carga = Carga + peso de la garrucha del gancho y del mecanismo de elevación.

Los valores de carga para la pluma principal sólo son válidos cuando no hay plumines instalados.

Valores de carga > 179 t requieren un mecanismo de elevación suplementario.

Valores de carga > 190 t requieren una unidad especial.

Se reserva el derecho a modificar las capacidades de carga.

Nota: Los detalles contenidos en este folleto sirven sólo como información general. Los valores determinantes para el funcionamiento de la grúa son los cuadros de cargas correspondientes, así como las instrucciones de funcionamiento.

Las capacidades de carga se indican por longitud de pluma para los diferentes niveles de despliegue. Las longitudes reales de la pluma pueden variar.

Le tabelle di portata sono conformi alle norme EN 13000:2010-10.

I valori delle tabelle di portata sono conformi anche ai requisiti delle norme ISO 4305 e DIN 15019, Parte 2, per quanto riguarda la stabilità, ed alle norme DIN 15018, Parte 3, e FEM 5004 per quanto riguarda il calcolo di resistenza della struttura.

I valori di portata sono indicati in tonnellate.

Capacità di portata = carico utile + peso del gancio e accessori di sollevamento.

I valori delle tabelle di portata per il braccio principale si applicano solo con le punte bracci smontate.

Valori di portata > 179 t richiedono un'attrezzatura supplementare.

Valori di portata > 190 t richiedono un'unità speciale.

Si riserva il diritto di modificare i valori di portata.

Nota: i dettagli forniti nel presente opuscolo servono solo come informazioni di carattere generale. I valori determinanti per il funzionamento della gru sono le tabelle di portata appartenenti alla gru stessa e le istruzioni di funzionamento.

Le capacità di sollevamento sono relative alla lunghezza del braccio con differenti configurazioni di telescopaggio. Le lunghezze reali del braccio possono variare.

Грузоподъемность соответствует EN 13000:2010-10.

Кроме того, грузоподъемность удовлетворяет требованиям ISO 4305 и DIN 15019 (часть 2) в отношении устойчивости, и DIN 15018, (часть 3), и FEM 5004 в отношении прочности материала.

Грузоподъемность приведена в тоннах.

Грузоподъемность = Полезный груз + вес крюкового блока и устройства для подвешивания.

Грузоподъемность основной стрелы только при сложенном удлинителе.

Грузоподъемность > 179 т необходимо дополнительное оборудование.

Грузоподъемность > 190 т необходимо специальное оборудование.

































Оставляем за собой право изменять грузоподъемность.

Примечание: В данной брошюре приведена только общая информация. Рабочие значения для крана приведены в таблицах грузоподъемности (см. данную брошюру и инструкции по эксплуатации).

Грузоподъемность приведена по длине стрелы для различных уровней телескопирования. Действительная длина стрелы может варьироваться.

Notes • Hinweise • Notes • Notas • Note • Примечания

Symbols • Symbolerklärung • Glossaire des symboles • Glosario de simbolos • Glossario dei simboli • Символы

	Axles Achsen Ponts Ejes Assali Оси		Crane functions Kranbewegungen Mouvements de la grue Funciones de la grúa Funzioni della gru Функции крана		Hookblock / Capacity Hakenflasche / Traglast Moufle / Force de levage Gancho / Capacidad Gancio / Capacità Крюковой блок / Грузоподъемность		Speed Geschwindigkeit Vitesse Velocidad Velocità Скорость
	Axle load Achslast Charge à l'essieu Carga por eje Carico sugli assi Нагрузка на ось		Crane travel Fahrstellung Déplacement de la grue Grúa en traslado Traslazione gru Перемещение крана		Hydraulic system Hydrauliksystem Circuit hydraulique Sistema hidráulico Impianto idraulico Гидравлическая система		Suspension Federung Suspension Suspensión Sospensioni Подвеска
	Boom Ausleger Flèche Pluma Braccio Стрела		Drive/Steer Antrieb/Lenkung Direction/Déplacement Tracción/Dirección Trazione/Sterzo Ведущие/Управляемые оси		Lattice extension Gitterspitze Extension treillis Extensión de celosía Falcone tralicciato Гусек		Transmission / Gear Getriebe / Gang Boîte de vitesses / Rapport Transmisión / Cambio Trasmisione / Cambio Трансмиссия / передача
	Boom elevation Wippwerk Relevage Elevacion de pluma Elevazione braccio Подъем стрелы		Electrical system Elektrische Anlage Circuit électrique Sistema eléctrico Impianto elettrico Электросистема		Lattice extension (luffing) Gitterspitze (wippbar) Extension treillis (volée variable) Extensión de celosía (angulable hidráulicamente) Falcone tralicciato (inclinabile) Гусек (с изменением вылета)		Travel speed Fahrgeschwindigkeit Vitesse de déplacement Velocidad de desplazamiento Velocità di traslazione Скорость движения
	Boom telescoping Teleskopieren Télescage de flèche Telescage de pluma Lunghezza braccio Выдвижение стрелы		Engine Motor Moteur Motor Motore Двигатель		Luffing Jib Wippspitzenausleger Volée variable Plumín angulable Falcone a volata variabile Маневровый гусек		Tyres Bereifung Pneumatiques Neumáticos Pneumatici Шины
	Brakes Bremsen Freins Frenos Freni Тормоза		Free on wheels Freistehend Sur pneus Sobre neumáticos Su gomme Свободные внутренние колеса		Low range Kriechgang Gamme basse Marchas cortas Fuoristrada Низкий диапазон		
	Cab Kabine Cabine Cabina Cabina Кабина		Gradeability Steigfähigkeit Aptitude en pente Superacion de pendientes Pendenza superabile Преодолеваемый уклон		Outriggers Abstützung Calage Estabilizadores Stabilizzatori Выносные опоры		
	Carrier frame Chassis-Rahmen Châssis porteur Bastidor Telaio Рама тягача		Main hoist Haupthubwerk Treuil principal Cabrestante principal Argano principale Лебедка основного подъема		Radius Ausladung Portée Radio Raggio Вылет		
	Counterweight Gegengewicht Contrepoids Contrapeso Contrappeso Противовес		Auxiliary hoist Hilfshubwerk Treuil auxiliaire Cabrestante auxiliar Argano secondario Лебедка вспомогательного подъема		Slewing/Working range Drehwerk/Arbeitsbereich Orientation/Rayon d'opération Giro/Gama de trabajo Rotazione/Area di lavoro Поворот/ Рабочий диапазон		

Manitowoc Cranes

Regional headquarters

Americas

Manitowoc, Wisconsin, USA

Tel: +1 920 684 4410

Fax: +1 920 652 9778

Shady Grove, Pennsylvania, USA

Tel: +1 717 597 8121

Fax: +1 717 597 4062

Europe and Africa

Dardilly, France - TOWERS

Tel: +33 (0)4 72 18 20 20

Fax: +33 (0)4 72 18 20 00

Wilhelmshaven, Germany - MOBILE

Tel: +49 (0) 4421 294 0

Fax: +49 (0) 4421 294 4301

China

Shanghai, China

Tel: +86 21 6457 0066

Fax: +86 21 6457 4955

Middle East and Greater Asia-Pacific

Singapore

Tel: +65 6264 1188

Fax: +65 6862 4040

Dubai, UAE

Tel: +971 4 8862677

Fax: +971 4 8862678/79



This document is non-contractual. Constant improvement and engineering progress make it necessary that we reserve the right to make specification, equipment, and price changes without notice. Illustrations shown may include optional equipment and accessories and may not include all standard equipment.

Die Angaben in diesem Dokument erfolgen ohne Gewähr. Wir verbessern unsere Produkte ständig und integrieren den technischen Fortschritt. Aus diesem Grund behalten wir uns das Recht vor, die technischen Daten, die Ausstattungsdetails und die Preise unserer Maschinen ohne Vorankündigung zu ändern.

Ce document est non-contractuel. Du fait de sa politique d'amélioration constante de ses produits liée au progrès technique, la Société se réserve le droit de procéder sans préavis à des changements de spécifications, d'équipement ou de prix. Les illustrations peuvent comporter des équipements ou accessoires optionnels ou ne pas comporter des équipements standards.

Este documento no es contractual. El perfeccionamiento constante y el avance tecnológico hacen necesario que la empresa se reserve el derecho de efectuar cambios en las especificaciones, equipo y precios sin previo aviso. En las ilustraciones se puede incluir equipo y accesorios opcionales y es posible que no se muestre el equipo normal.

Documento non contrattuale. In considerazione della sua politica di costante miglioramento dei prodotti connesso al progresso tecnico, la Società si riserva il diritto di modificare senza preavviso specifiche, equipaggiamenti o prezzi. Le illustrazioni possono contenere equipaggiamenti o accessori optional o non contenere equipaggiamenti standard.

Данный документ не является контрактным. Принимая во внимание необходимость постоянного совершенствования и модернизации мы оставляем за собой право изменять спецификации, конструкции и стоимость без предварительного уведомления. Приведенные иллюстрации могут содержать дополнительные компоненты и принадлежности, не входящие в стандартный комплект поставки оборудования.